

# ISUZU MU-X

2025 (MY25) - CURRENT

# MAZDA BT-50

2026 (MY26) - CURRENT

TOWING MIRRORS  
INSTALLATION GUIDE

Towing Mirrors

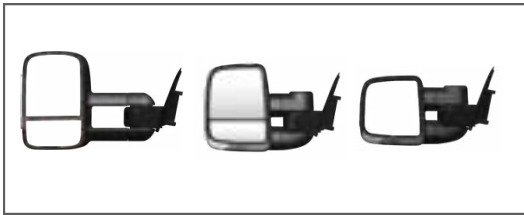

Power Boards And Swing Boards



Rock Tamers



Tyre Spider

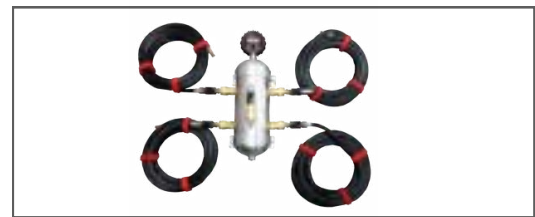

Easy Slides



Power Slides



Expanda Slides



Fridge Cage



Pantry

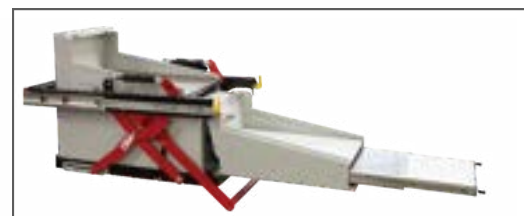

Cutlery Set



Clip on Trays

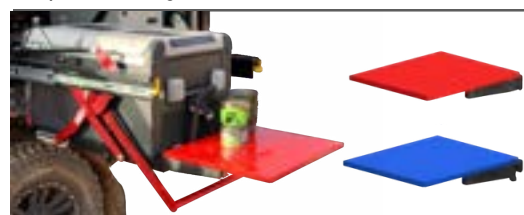

Cable Saver

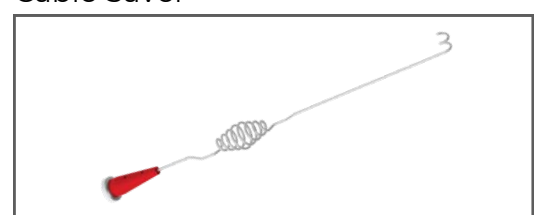

## Thank you for choosing Clearview Accessories®

When it comes to road safety, having full visibility of your vehicle and your caravan, trailer or horse float is paramount. Clearview Towing Mirrors extend your field of vision when towing, changing lanes or reversing, to help see you to your destination safely. From Cape York's Telegraph Track to the Gibb River Road, Clearview Towing Mirrors are purpose-built tough for Australian conditions!

Clearview Accessories began in 2006, as a family run business owned by entrepreneur Mike Cowan and his son-in-law Jay Praag. In the years that followed, Mike and Jay turned their small family business with three full-time employees, into one of Australia's most respected 4WD and Touring Brands.



With a strong passion for the automotive industry, quality design and discipline in professional workmanship, our trust is built within our values of creating high quality ADR compliant designs.

From humble beginnings, Clearview Accessories has grown and today manufactures a range of unique, quality products for your next off-road adventure!

### Contact us:

Clearview Accessories,  
3 Frog Court, Craigieburn VIC 3064  
Phone: (03) 8351 9933  
Email: [info@clearviewaccessories.com.au](mailto:info@clearviewaccessories.com.au)  
Website: [clearviewaccessories.com.au](http://clearviewaccessories.com.au)

### Find us on social media

-  [facebook.com/clearviewaccessories](https://facebook.com/clearviewaccessories)
-  [instagram.com/clearviewaccessories](https://instagram.com/clearviewaccessories)
-  [youtube.com/CLEARVIEWACCESSORIES](https://youtube.com/CLEARVIEWACCESSORIES)

Due to Clearview's Continuous Improvement Program, information may change without notice. Clearview takes no responsibility for the result of incorrect use of these installation instructions.

Our range	2
Introduction	3
Getting started	5
Before you Start	6
Maintaining your Mirrors	7
Mirror dimensions	8
Fitting instructions	10-27
FAQS	28
Troubleshooting	29-30
Warranty	31

Clearview mirrors are direct replacement mirrors that mount securely in the same position as your original mirrors.

## What's in the box

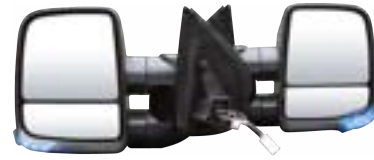

- 1 x Left hand side mirror & base
- 1 x Right hand side mirror & base
- 1 x Installation instruction
- 1 x Lower Access Panel (if mirror does not contain 360° camera feature)
- 1x 360° Camera Kit (if mirror contains 360° Camera feature)

### If you have purchased a camera model mirror:

Within the shipping box with the mirror head, you will find a camera bracket kit for your make of vehicle. This kit will contain:

- A.** 1 x LH and 1 x RH camera lower access panels (parts marked/inscribed LH or RH)
- B.** 1 x LH and 1 x RH camera brackets (parts marked/inscribed LH or RH)
- C.** 4 x camera bracket attaching screws



If anything is missing, or damaged, please do not install your new mirrors and contact us on **03 8351 9933** or via: [info@clearviewaccessories.com.au](mailto:info@clearviewaccessories.com.au)

### Tools Required:

1. Door Trim Plier Removal
2. Plastic Pry Tool - Narrow & Wide
3. Trim Clip Removal
4. "S" Hook
5. Flat & Phillips head screwdriver
6. Torque Wrench
7. M10 Socket & Phillips head bit driver with DC Gun.(Makita 12V)
8. Ratchet with M10 Socket head
9. Chalk Marker



Whilst our mirrors can be installed by one person, the process is quicker and easier when an additional person is available to hold the mirror into position.



**CAUTION**



**WARNING**

- Read through the fitting instructions before installation of Clearview Accessories.
- Always install the accessory following the fitting instructions. Failure to do so may cause damage to the vehicle or the accessory and will void your warranty.
- Ensure all packaging materials are recycled and/or disposed of in accordance with local regulations.
- It is always recommended that this accessory is fitted by a qualified technician.
- Safely store and protect any removed vehicle components.
- Ensure all bare metal surfaces are protected using Automotive Bare Metal Primer and touch-up paint.
- Remove all metal swarf and dust from all vehicle surfaces if the surface is used for accessory installation.
- Your vehicle may be fitted with the Active Park Assist feature. You should only use this feature with your Towing Mirrors in the fully retracted, driving position.



**POWER FOLD**

**WARNING**

**DO NOT UNFOLD MANUALLY**

If your mirror is equipped with Power Fold. In some cases, the mirror head may be loose before installation as the mirror head needs to be electrically folded and unfolded for a minimum of cycles on its first use to synchronise.

Please refrain from folding the mirror MANUALLY as it can reduce the life span of the product.

- **NB:** This mirror is designed to be manually folded upon impact as a safety feature.

## COURTESY/PUDDLE LIGHT

Please understand that every car and every model is different and that some vehicles have different wiring options than other vehicles. We do not know the exact wiring configuration of your vehicle.

If you require the use of the courtesy/puddle light function you will require the assistance of an Auto Electrician.

- Clearview Accessories does NOT provide this service unless it's a standard function on the vehicle.

**NB:** Where there is an electrical modification of the vehicle, a suitably licenced person should undertake the work.

- IF HARD WIRING: **ORANGE WIRE: NEGATIVE (-) | GREY WIRE: POSITIVE (+)**

## Maintaining Powder Coated Surfaces

Whilst powder coating is a lot more durable, and longer lasting than paint, it can still be affected by dust, dirt, salt water and constant exposure to the weather. For this reason, no protective powder coating is completely maintenance-free.

With the right maintenance, you can increase the life of the finish of your powder coated surfaces:

- Harsh chemicals and solvents can damage powder coating. Once damaged, the surface is a lot more vulnerable to fading and failure.
- We recommend regularly inspecting your powder coat and wiping any dust off with a soft cloth. Clean, good quality micro-fiber cloths are recommended.
- We recommend regular washing with highly diluted mild soap and water. Use a soft towel to gently clean. Rinse and dry with another soft towel.
- If your powder coat is losing its shine, you can apply a thin layer of high-grade non-abrasive car wax after it's been cleaned. Wipe all the wax off once its dried and the powder coat should look like new again! Use a car wax brand that contains a UV blocker or UV inhibitors. Do not use compound-type waxes as they contain abrasives that can harm the powder coating.

It's important in coastal areas to regularly clean any powder coated surfaces as salt will stick to the coating, dulling its appearance. This can leave your powder coated surface looking chalky. We don't recommend paint touch ups to cover imperfections as paint won't adhere to powder coated surfaces. A local professional can quote to repair the powder coating.

## How do I maintain my Powerfold mirrors?

Under normal Powerfold operation, there shouldn't be any maintenance required. However, if it is regularly used off-road, then the mirrors may need to be maintained every 12 months. This maintenance involves pulling the mirror into the fully extended position and applying dry lubricant on the arms.

## Maintaining your Chrome Mirrors

The chrome finish used on our mirror heads is a chrome plated plastic, which provides the appearance and feel of real chrome, in a more lightweight and cost-effective material.

Weather conditions, how often they are washed and how close to the ocean you live, all play a role in the longevity of the chrome finish.

- Automatic car washes that use bristle brushes or acidic preparations can damage your chrome
- Salt and de-icers will surface pit chrome and extra care will be required with more frequent washes to remove residue.
- We recommend washing them weekly with mild soap and water, steering clear of ammonia-based or acid solutions.
- Clean, good quality micro-fiber cloths are recommended to wipe down the chrome surface and prevent water stains from forming
- An occasional polish with a non-abrasive chrome polish will help bring your chrome back to its original shine!

If chrome isn't properly maintained, it can develop pitting from corrosion or lose its attractive shine. We recommend Autosol Metal Polish and Autosol Metal Life Saver

## Compact Towing Mirrors

Non-Extended Standard Driving Position



Extended Towing Position

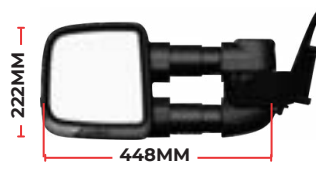

Fully Extended Towing Position

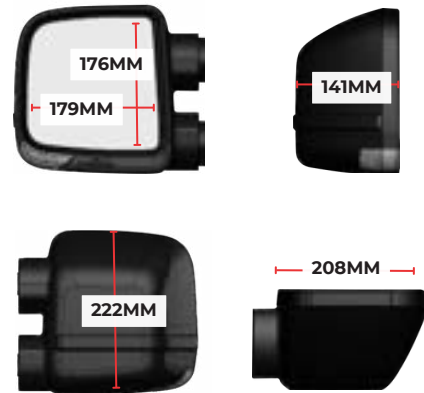
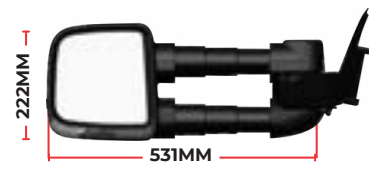

## Next Gen Towing Mirrors

Non-Extended Standard Driving Position



Extended Towing Position

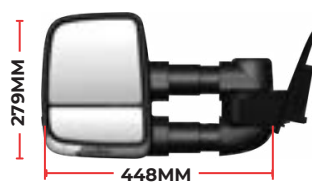

Fully Extended Towing Position

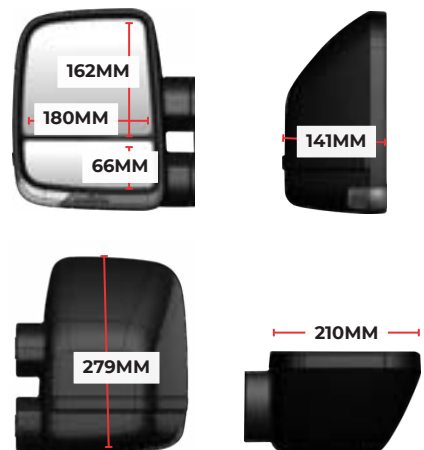
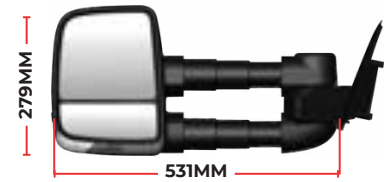

Your adventure awaits...  
Let's Begin!



## Step 1

### Prepare vehicle:

Place transmission into park position with handbrake on.

**Turn ignition on and lower front door glass/windows.**

Turn ignition off/ remove key and disconnect the battery before proceeding to next step.



**Disconnect the battery by removing the negative terminal before taking off the OEM mirrors. Do not reconnect the battery until the camera wiring has been properly connected to the cameras in the new towing mirrors.**



Use M10 Spanner for removing the Nut of Battery -VE Terminal



Cover the battery connectors with a fabric cloth to prevent accidental contact with the negative (-) battery terminal.

## Step 2

### Remove corner door trim:

Remove Phillips head screw from door upper corner trim.  
This will enable the plastic clip securing the trim to be removed.

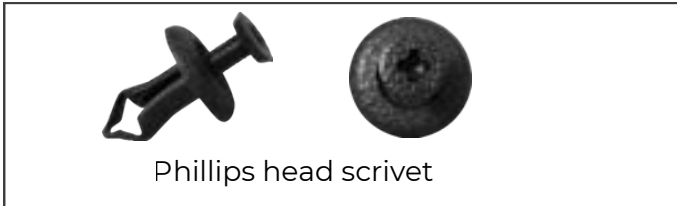

Remove the corner trim using your hands. Pull out and Up. Make sure you dont damage the bottom tabs.



Removing the Trim exposes the three M10 hex-head screws securing the mirror head. The bottom two screws are accessible after removal of the door trim panel (refer to Step 9).

## Step 3

### First door panel screw:



Using the soft plastic pry-bar, insert and lever the small door trim cover behind the door handle.



Remove the phillips head screw without washer.

## Step 4

Second door panel screw:



Remove the armrest cover by lifting it upward and outward by hand.



Remove the second single phillips head screw with washer.

## Step 5

Third door panel screw:



Remove the window operating push-button trim, using the plastic pry tool, by inserting as shown and levering upward.

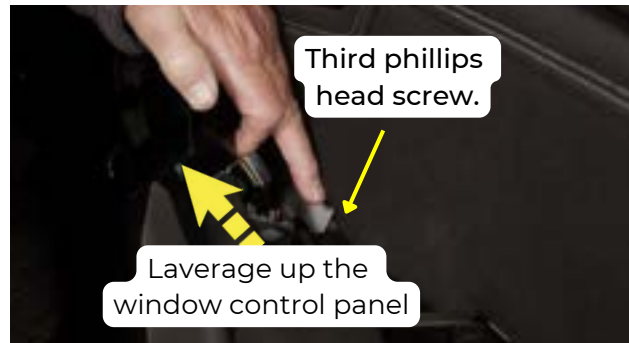

Remove the third single phillips head screw with Washer.

## Step 6

Keep screws:

Using a Phillips-head screwdriver, remove the three screws securing the door trim. Retain the screws for reinstallation in their original positions.

Note: The 2 arm cover screws have a washer attached to the screw.



## Step 7

Remove door panel:



Insert the plastic pry tool under the bottom rear corner of the door trim.



Lever the door trim outward to disconnect from all retaining clips.



Lift the door trim upward and position onto 'S'-hook, to support the door trim during installation.

Note that the door trim must remain electrically connect to the vehicle door.

## Step 8

Disconnect door wiring:

- You now have access to the mirror electrical connection which you will disconnect.
- Disconnect the single white connector.
- Also disconnect the 360° camera plug. Using a small screwdriver or your fingernail, pull the clip back; once it's retracted, press down on the green clip and unplug it (**if the mirror contains the 360° camera feature**).

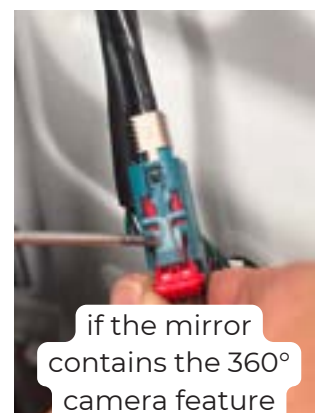

## Step 9

### Remove the mirror:

With Philips head Screw driver/Gun, remove the 3x M10 Hex Head, mirror head mounting screws.

Support the mirror from outside during this operation.



Remove the mirror from the doors, threading the electrical connector through the opening.



**HANDY TIP:** Keep your original OEM mirrors as back up should something happen to one of your Clearview Mirrors, necessitating the need to return it to us for repairs.

## Step 10

### Remove the Towing Mirror etc. from the shipping box:

Remove complete mirror heads from box.  
Remove all 3x M6 hex head screws from the mirror base and retain for Step 12.

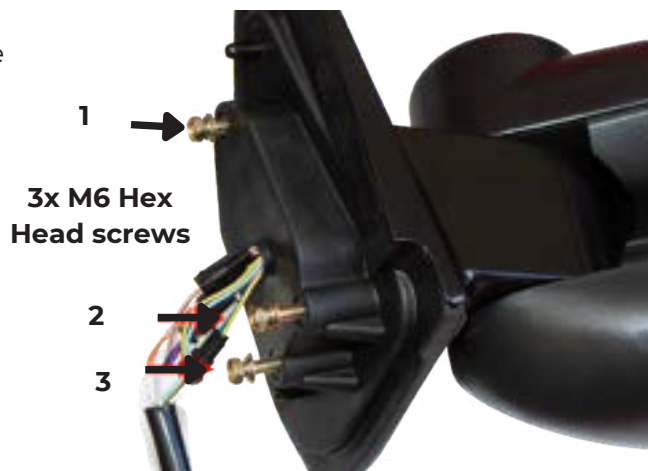

## Step 11

### Attach the Towing Mirror to the Vehicle:



For ease of handling the Towing Mirror during installation, extend the mirror head to the mid-position.



Present the Towing Mirror head base to the door panel mounting position.

Feed the electrical wiring and connecting plug, through the central opening.

Align the Towing Mirror Head Base to the 3 mounting holes in the door panel.

Push the Towing Mirror head base gently home and ensure that the electrical wiring is pulled fully through, this is to avoid trapping of the wiring between the door panel and the mirror base when the screws are secured.

Hand-start the 3x M10 hex head screws, to avoid cross threading of the screws.

Once done connect the connector plug.



## Step 12

Tighten screws and connect wiring:



With the ratchet, fully tighten all 3x M6 hex head screws to secure the Towing Mirror head to the vehicle door. (Torque upto 12N/mm)



Connect the Towing Mirror single white connection plug to the door wiring.

### IMPORTANT

- If the mirrors do not have the 360° camera feature, **SKIP to STEP 14.**
- If the mirrors contains the 360° camera feature, please follow the next steps.

## Step 13

Installation of 360° Camera

### Step 13a

Prepare mirror head for fitment of camera & lower access panel



1. Remove the Mirror head from the box LH and RH and keep it on the bench for fitment of LAP and camera bracket.

The Arrow shows the opening where the Lower Access Panel will be clipped.

## Step 13b Remove parts from camera bracket kit

- Within the shipping box with the mirror head, you will find a camera bracket kit for your make of vehicle. This kit will contain:
  - A. 1 x LH and 1 x RH camera lower access panels (parts marked/inscribed LH or RH)
  - B. 1 x LH and 1 x RH camera brackets (parts marked/inscribed LH or RH)
  - C. 4 x Camera bracket attaching screws



## Step 13c Remove 'OEM' cameras from your original vehicle exterior mirrors

The 'OEM' cameras are located in the lower/outer corner of your original exterior mirrors



Before removing the OEM mirror cover, mark the edge of the camera (facing the glass) with white pencil/Chalk marker from the glass side of the mirror, to the middle of the camera as shown for both LH and RH side. This will ensure that when assembling it into the CV towing mirrors, the camera align correctly with the OEM position after the assembly.

To remove the cameras (x2) from the original exterior mirror you must first remove the bezel and covers from the original exterior mirrors.

The following pages detail the procedure for the stripping down of the original exterior mirror and removing of the OEM Cameras. After removing both of your OEM Mirrors, place them on a sturdy bench top.

## Remove Exterior Mirror Glass



1. Press mirror glass down at bottom inside corner.
2. Insert flat blade screwdriver or Plastic Pry tool from the side under glass and lever upward to separate glass from mirror glass motor as shown.

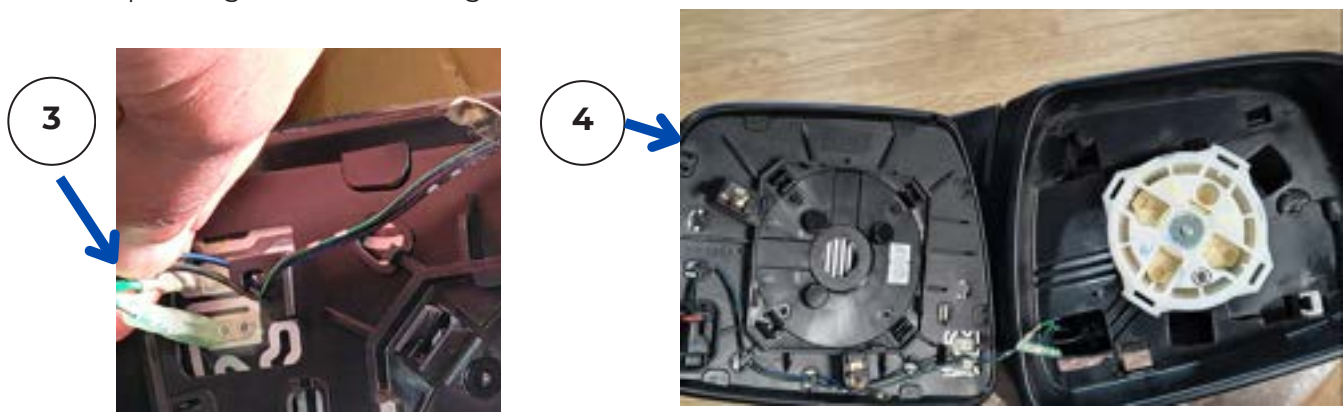

3. Disconnect 2 x heater electrical connection from glass
4. Move the Glass aside so you can have access to the Tabs as shown in next page

## Remove Exterior Mirror Bezel & Cover

1. Insert the plastic pry tool gently to separate the bottom cover from the OEM Mirror Housing.





2. Gently insert the plastic pry tool between each tab, one at a time, to loosen the top housing cover.

3. After 2nd step now insert a plastic pry tool between the edges of the housing cover as shown to take off the covers while pushing it outwards. Slowly separate it from the housing until it loosens. Then, gently pull off the exterior mirror cover by hand.



4. Remove the two exterior mirror bezel screws using a Philips Head Screw Driver.



5 Repeat steps 2 and 3 to remove the bottom cover. First, loosen the highlighted tabs as shown on LHS image, then insert a pry tool between the edges to detach it.

## Remove OEM Camera and Camera Plug and Bracket from OEM Exterior Mirror



**Tip: Ensure that your left side 360 camera, is kept and installed with your left side Clearview Towing Mirror, and the right side is kept and installed in the right side.**

1. You now have access to the OEM camera. It is located at the base of the Lower Panel.

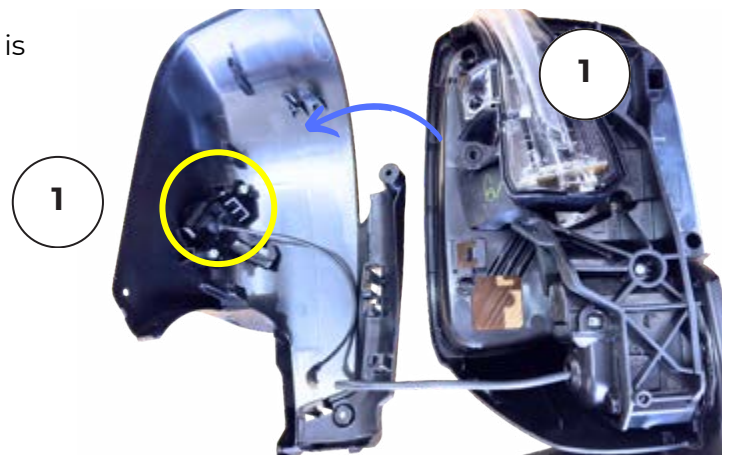

2. Once you detach the Plastic MIC OEM Cover turn around as shown in above image and remove the outer 2 M4 Philips Head Screws with a screwdriver as highlighted below to separate the camera bracket. **(The Screws can be discarded as CV Mirrors will be providing hardware's for camera bracket in the kit.)**

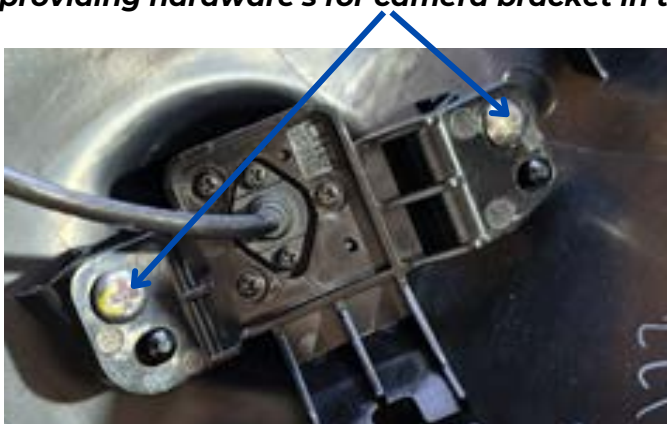

## Remove Camera Bracket & Connecting Plug from OEM Camera

3. Once camera bracket is separated remove the inner 3 - M2 Philips Head Screw as shown with a screwdriver to separate the camera with the loom. (Please retained these M2 screws for assembly in the CV Bracket)

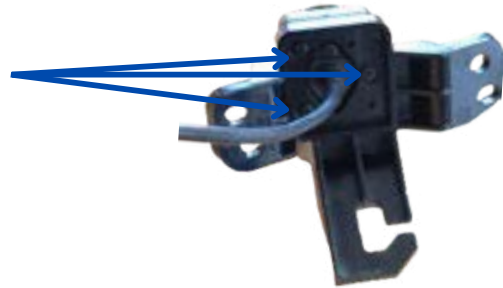

4. As the camera is separated now remove the 2-M2 screws from the back as shown to separate the camera loom. (Please retain these M2 screws for assembly in the CV Mirror)

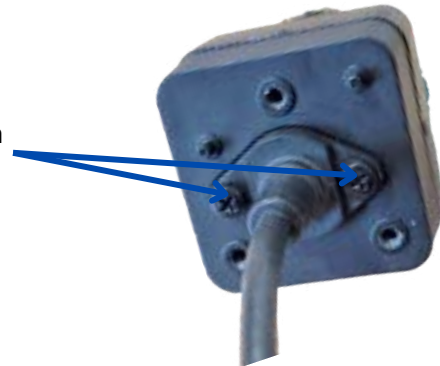

5. This is how your OEM cameras should look with the wiring plug and retaining bracket now removed. Retain the wiring plug aside, as you will later use to connect to the camera when assembled in the CV Mirror housing.



**TIP:** DO NOT mix up the 360° cameras when removing them from the OEM mirror.

- **LEFT Camera** installed in the LEFT-HAND SIDE (LHS) Clearview Towing Mirror; AND
- **RIGHT Camera** installed in the RIGHT-HAND SIDE (RHS) Clearview Towing Mirror.

## Step 13d

### Assemble 'OEM' cameras to new lower access panels

1. Assemble the 'OEM' cameras to the camera lower access panel and align the camera in position using the camera brackets and screws provided, as shown. Do not securely tighten the screws yet.

#### LH side only shown

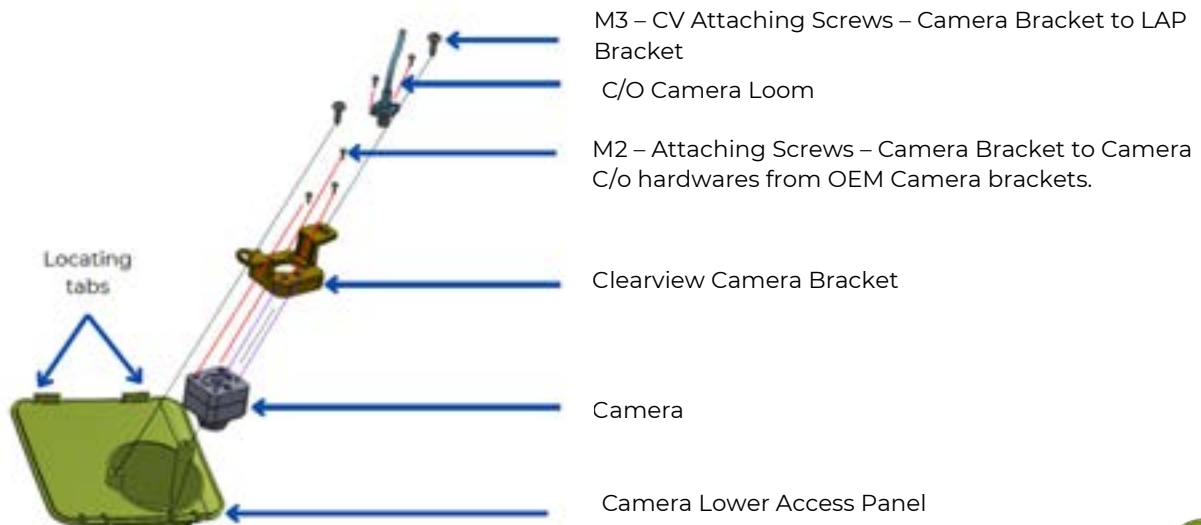

2. Align the OEM camera within the bracket and fasten it using the M2 hardware (circled in yellow). Then, position the camera bracket onto the LAP, securing it over the mounting lugs as shown.

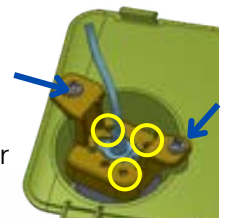

3. Make sure after the camera assembly in the CV LAP the mark is facing towards the glass so that we can assure this is the correct position of camera as per OEM



Note: camera wire & plug will be connected as part of the step 14

4. Position the camera brackets, as shown, with the attaching screws located approximately in the mid point of the slots. The attaching screws can now be tightened

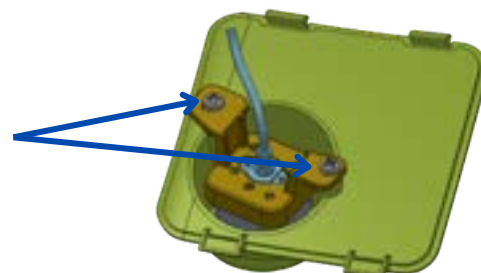

## Step 14

**Install the new lower access panels—either with camera provision or without—depending on the vehicle’s 360° camera availability**

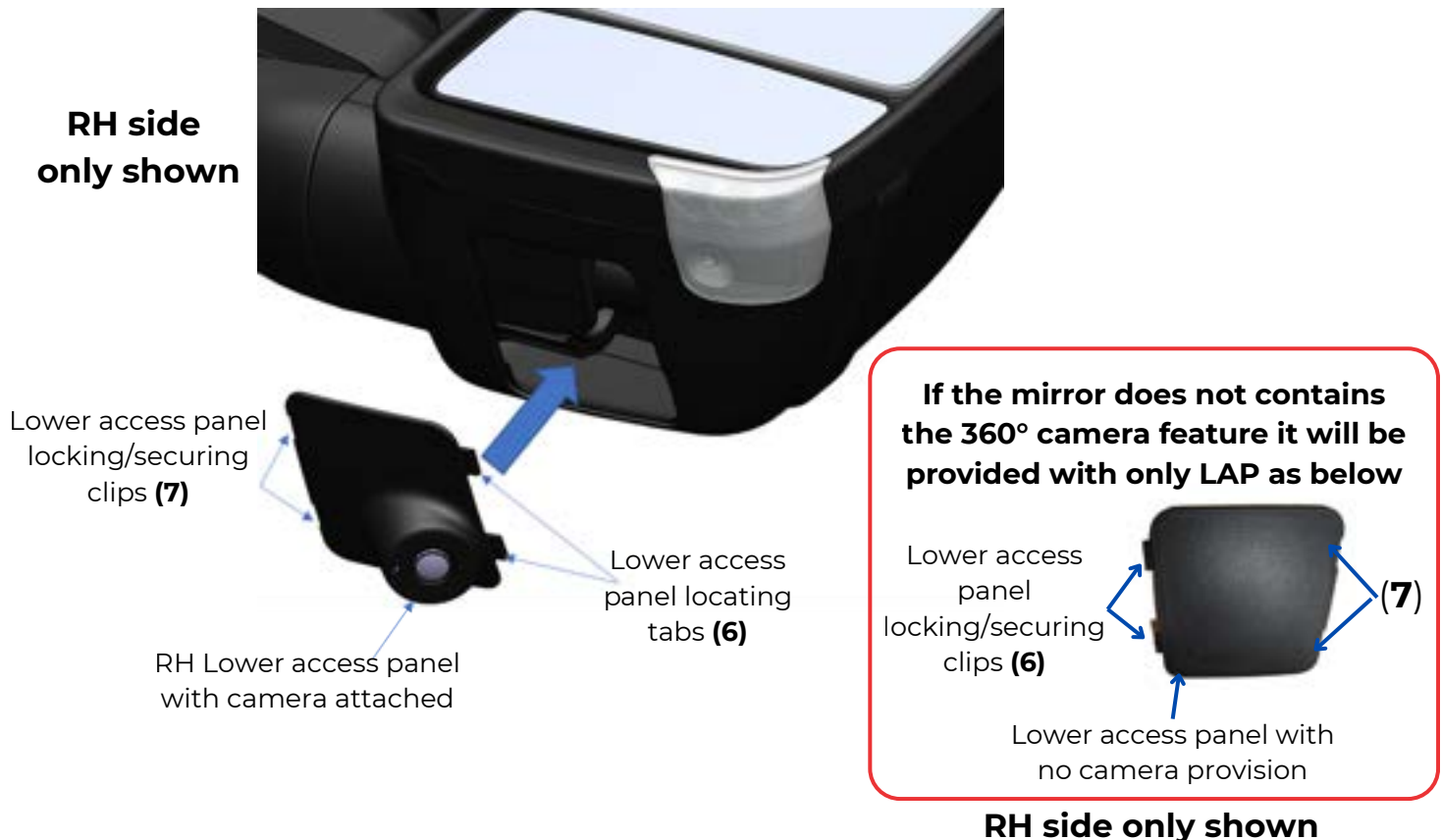

With ‘OEM’ camera secured to the lower access panel – begin with right hand side mirror head. **(If the mirror contains the 360° camera feature refer to image above)**

1. Locate the camera wiring plug immediately inside the mirror head.
2. Connect this wiring plug to the mating plug on the camera wiring lead.
3. Ensure the 2 mating plugs are completely connected.
4. As you position the lower access panel to the mirror head, allow the wiring to fit into the mirror head opening.
5. Ensure that the wiring is not trapped or interfering with the fitment of the lower access panel.
6. Position the lower access panel 2 locating tabs into the slots in the mirror head opening. These slots are on the outside of the mirror head.
7. Now pivot the inner side of the lower access panel up until the locking clips are in contact with the mirror head opening.
8. Apply localised pressure to this edge of the lower access panel until the locking clips snap into position.
9. The lower access panel/camera assembly is now in position.
10. You are now ready to test alignment of camera.

## Step 15

### Check Towing Mirror Functions

- **If you previously disconnected the battery, you can now reconnect it.**
- Turn ignition on and operate the mirror function of Towing Mirror based on features available in vehicle
- Electric Mirror glass movement
- Mirror Head Turn Signals
- Blind Spot Monitoring
- Mirror Glass Heaters and
- Mirror Head Courtesy Lights
- Power Fold of Mirror Head
- Memory
- 360° Camera

#### **IMPORTANT**

- If the mirrors do not have the 360° camera feature, **SKIP to STEP 17.**
- If the mirrors contains the 360° camera feature, please follow the next steps.

## Step 16

### Check and Adjust 360° Camera Alignment on Vehicles

#### Preparation for testing:

1. Park the vehicle on a flat, clear surface.
2. Use masking tape or an aluminium square bar (30 mm - Sq bar) for alignment.
3. Ensure a minimum of 1 metre of clear space on each side of the vehicle.
4. Place two horizontal bars or masking tape lines on the floor, positioned equally 500 or 600 mm outward from the centre of the front and rear wheel hubs.
5. Position the Aluminium Sq. bar or Masking tape 90° to horizontal bar and run it approximately the full length of the vehicle.
6. Position a horizontal bar or masking tape line across the top, positioned at 90° to the vertical lines.
7. Ensure all bars/masking tape are 30 mm wide so they are clearly visible on the vehicle's 360° camera display.
8. Refer to the vehicle owner's manual for instructions on accessing the 360° camera screen.

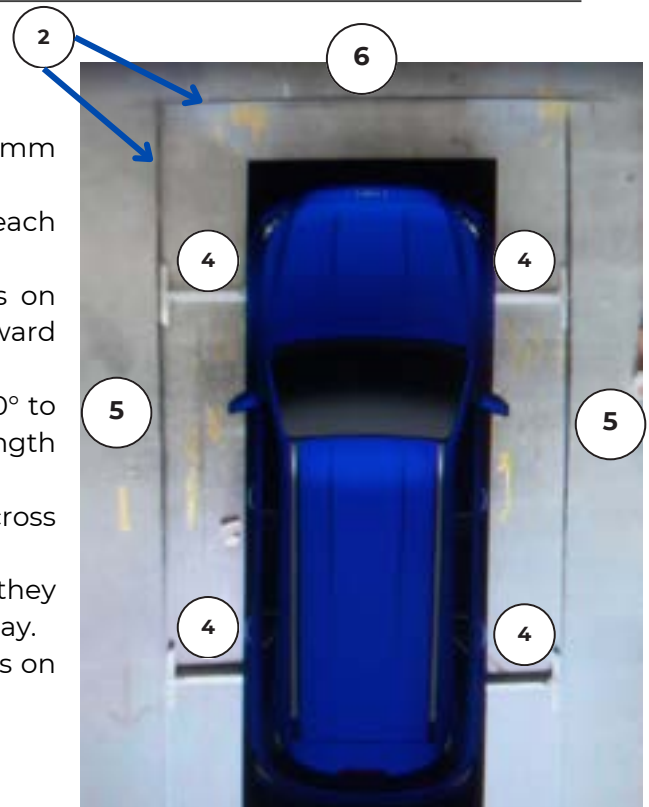

2 Vertical bars OR Masking Tape lines (marked 2) on floor approx. 600mm away from center of the wheel hub and 1 Horizontal bar/line at the Top.(marked 6)

## Check and Adjust 360° Camera Alignment on Vehicles

### View 360° camera alignment

1. Turn on vehicle 360° camera screen – refer to vehicle owner's manual.
2. With Clearview towing mirrors firmly attached and electrically connected to vehicle and lower access panel & camera assembly securely in position, close all vehicle doors fully.
3. Ensure that the mirror heads are fully retracted and in the drive position. Operate the mirror fold feature to ensure in drive position.
4. Whilst seated in the vehicle, view the 360° camera screen to check the alignment of the parallel lines on the floor surface – the black (Masking lines )
5. **You want to see these lines being parallel to the longitudinal lines of the vehicle – the yellow dotted lines, which comes when you move your gear to Reverse as shown.**
6. If the lines are not parallel, you may want to adjust the angle of the camera on the lower access panel until these line are parallel. Refer below for instructions on how to adjust the cameras.
7. Ensure the parallel lines are properly aligned to provide customers with an accurate view of the parking guidelines
8. Repeat above steps for the LH camera.



**Tip: complete alignment on one side at a time. Open and close the respective door whilst viewing the lines on the screen. To determine if you need a clockwise or anti-clockwise adjustment.**



Press Camera Button  
to view the 360°  
camera screen

## Check and Adjust Camera Alignment on Vehicle

### Adjust camera alignment on vehicles

1. Keep the Vehicle ON in running Position - In Park mode.
2. Remove lower access panel, with camera attached, by unclipping 2 Tabs from Mirror head (as highlighted below in yellow) (**PN : Do not detach the camera cable from camera**)
3. Unscrew the 2 attaching screws just enough to enable movement of the camera bracket assembly.
4. Maintain downward pressure on the camera bracket so that it does not move prior to your adjustment.
5. Adjust the camera alignment by rotating the camera bracket & camera assembly a small amount, either clockwise or anti-clockwise.
6. Re-secure the 2 attaching screws to hold the camera in the adjusted position.
7. Re-fit the lower access panel, with camera secured in adjusted position, into the mirror head as instructed earlier.
8. Check now the 360° View on the screen OR move the Gear in Reverse to check the alignment of the Parking lines parallel to the Masking tape/bars as per previous step no. 10 instructed in 'View Camera Alignment'/'
9. Repeat 'adjust' & 'view camera alignment' steps until you are satisfied with the alignment of the parallel lines on both the RH and LH side of the vehicle.

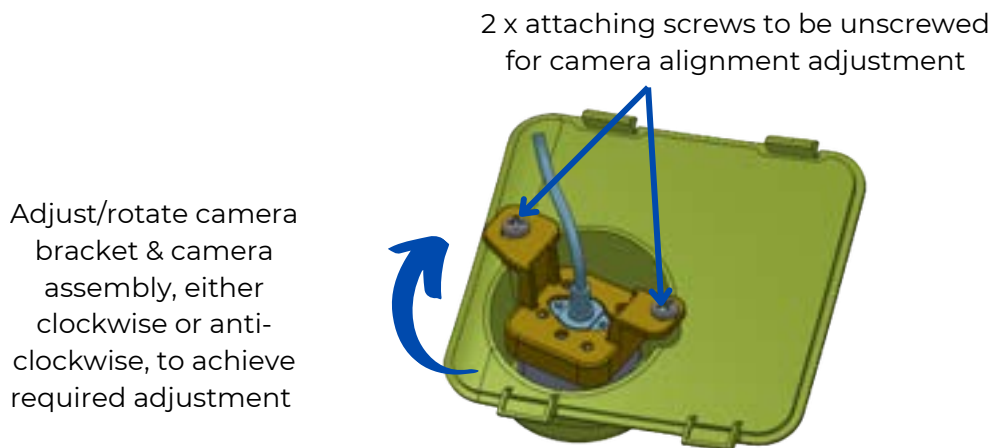

**Congratulations! You have now fully installed your new Clearview towing mirrors with 360° cameras.**

**N.B. If you experience any issues with the ADAS features or 360° camera view after installing the Clearview mirrors, please consult a qualified diagnostics tool software technician at your vehicle's dealership**



**WARNING The 360° Camera from OEM has been relocated to CV Towing mirrors. So Parking Guidelines are approximate and might not be the same as OEM**

## Step 17

### Re-assemble the door trim:

Lift the door trim off the 'S'-hook and position back onto the door.

Tap around the edges of the door trim to secure the door trim into the retaining clips.



## Step 18

### Secure door trim:

Secure the door trim into position using the same 3 Phillips head screws removed in steps 3, 4 & 5. Ensure that the screws are returned into the same position from where they were removed.



## Step 19

### Fix remaining panels:

Door upper corner trim (Step 2).

Small trim cover (Step 3) and

the arm rest cover (Step 4).

Push each of these trims into position and ensure they are secure, using your hands.

Re-insert the plastic clip and screw previously removed in Step 2.

Congratulations! You have now fully installed your new Clearview Towing Mirrors and are ready for your next adventure!

**Can I install Clearview mirrors myself?**

Yes! Depending on the complexity of the installation, Clearview mirrors are extremely easy to install and mount to the vehicle's original OEM mirror mounts. Depending on the vehicle's current mirror options, Clearview mirrors include plug-and-play wiring looms. Instructional videos are also available on our website ([clearviewaccessories.com.au](http://clearviewaccessories.com.au)) in the 'HOW TO' section. Clearview recommends that any installation requiring hard wiring be done by a licensed auto electrician.

**What is the fitting time?**

Depending on the complexity of the installation, the fitting will vary from vehicle to vehicle. Any installation requiring any special fittings and/or hard wiring will require longer fitting times (eg. 360° Camera fitting/calibration, any electric hard-wiring kits, OAT sensors, and any other complex installations etc).

**NB:** Fitting times will also vary depending on the skillset or capabilities of the fitter.

Please contact Clearview Accessories if you have any questions about fitting or wiring.

**Are the telescopic arms electric?**

No. The telescopic arms are extended manually. Clearview Mirrors will only fold against the vehicle electronically provided we make that model in Power Fold.

**Can I retrofit the original mirror base to the Next Gen or Compact mirrors?**

No. The cost of converting the mirrors to suit the new models is not worth it. We recommend either selling your Original mirrors privately or through the 'Pre-Loved' section (Within the 'Shop' menu category) of our website and purchasing the new Next Gen or Compact mirrors brand new.

**Can I add an indicator later if I didn't order the mirrors with an indicator?**

Yes, you can. But it comes at a greater expense than if you were to order the mirrors with indicators. Installation of the mirror head will require a longer time and more parts to dismantle.

**Are spare parts available?**

Yes. We have a list of spare parts for all our mirrors on our website. Our dealers also have a list of all our spare parts. If you cannot find the parts that you require, please contact Clearview Accessories, or any of our dealers to assist you with your enquiry.

## How do I maintain my mirrors?

We recommend that Clearview Mirrors are lubricated every 6-12 months, when the arms feel stiff during use, or after any big trip to ensure longevity of your Clearview Towing Mirrors!

This maintenance includes pulling the mirror into the fully extended position and applying the dry lubricant on the arms. We recommend using WD-40 Specialist® Dry Lubricant.



Avoid any waxy lubricants as they can attract dirt and grit.

**SCAN THE QR CODE  
AND VIEW OUR VIDEO  
DEMONSTRATING**

How to lubricate the arms  
on Clearview Towing Mirrors



## **I have just installed my new Powerfold mirrors and the mirror heads appear 'loose'/floppy'.**

After the mirrors are installed, they need to be cycled a few times. This will allow all the internal mechanisms to set and find the proper positions.

- If the mirror head is still loose/floppy after they're cycled, please contact Clearview Technical Support.

## **I have installed my Powerfold Mirrors and have noticed that the Passenger's side mirror is closer to the vehicle compared to the Driver's side; Is this normal?**

This is entirely normal. In most vehicles, the mirror housings are angled differently between the driver's and passenger's sides.

- This is because when you sit in the car, the mirrors are positioned from/to the driver's position (which is off-centre), so generally, the passenger side mirrors are closer to the vehicle body to allow you to have the same field of vision in the mirror.

## **One of my Powerfold Mirrors folds/opens quicker than the other one; Is this normal?**

Generally, the passenger mirror will fold/open quicker, as it is closer to the vehicle body and therefore travels a shorter distance compared to the driver's side mirror. See previous question in regards to why the mirrors are angled differently.

## **My mirrors have been knocked out of Driving Position; how do I fix it?**

Press the powerfold switch once. This should initiate the powerfolding motors and the mirrors should start folding inwards. Wait until the mirrors are fully folded in and have stopped moving, then press the powerfold switch again. This should now bring your mirrors back out to normal driving position. Check and see if the mirrors are locked into position firmly. If the mirror is not returning to the normal position, please contact Clearview Technical Support.

**Note:** *The Powerfold mirrors can fold manually, however the manual fold mechanism is only designed as a safety feature. Through the lifespan of the product, manual folding will occur, such as people walking into them or accidentally bumping them. The internal mechanisms are designed to withstand this accidental manual folding during normal usage. It is not recommended for the mirrors to be manually folded constantly, as it will prematurely wear out the internal folding mechanisms and reduce the lifespan of the product.*

## **My mirror was knocked out of driving position. When I cycled them, there is a clicking sound and the mirror appears to have “jumped”; Are my mirrors damaged?**

When the Powerfold mirror is being cycled to find its original driving position, it will “jump” back into position and make an audible click sound when mechanisms realign. Once the mirrors have found the original position and have been cycled, check for looseness and mirror movement. If they feel firm, then the mirrors have not been damaged. If they still feel loose, please contact Clearview Technical Support.

## **Why don't my mirrors fold all the way in/out when I press the switch?**

The circuit breaker inside the mirror activates when the electrical current increases due to resistance. If the mirror stops before it reaches the folded in/out position, that means something is adding resistance while the mirrors are folding, hence activating the circuit breaker before it has reached the desired position. Please contact Clearview Technical Support.

Clearview Towing Mirrors® are full replacement towing mirrors designed and manufactured to the highest quality standards to replace your vehicle's standard side mirrors. We stand behind our Next Gen and Compact Towing Mirrors with a 3-year Manufacturer's Warranty and 7-year Parts Warranty. We stand behind our Original Towing Mirrors and Classic Towing Mirrors with a 12-Month Manufacturer's Warranty and 3-year Parts Warranty

Please ensure that your receipt is kept in a safe place. A receipt will be required to make a warranty claim on any Clearview product. If we determine that a Clearview Towing Mirror is defective in materials or workmanship during the Warranty, we will either repair or replace the product. Repair or replacement is solely at the discretion of Clearview Accessories.

Please ensure that you fit the Clearview products in accordance with the product information provided and all relevant vehicle safety and compliance laws; and use the Clearview product for the purpose for which it was originally designed. This warranty does not apply to failure or damage caused by incorrect or faulty fitment, accidental or intentional damage, alteration, acts of nature, vandalism, collision, road hazards or adverse conditions, misuse, abuse or neglect of the Clearview product, including improper repair or maintenance or failing to repair and maintain the product, failure of other products, operation of the product outside of its environmental or technical specifications, or repair or modification carried out by anyone other than Clearview Accessories®. No charges will be accepted for external labour or materials without the prior advice or clearance from Clearview claims team. Clearview Accessories® warranty does not cover any scratches or chips.

Clearview Towing Mirrors are designed to be vehicle-specific. When purchasing Clearview Towing Mirrors, carefully select your product according to ADR compliance laws and vehicle specifications. Clearview Towing Mirrors are not designed to be modified for convenient use on alternative vehicles. Alteration, modification, or manipulation of our products will void all warranty with Clearview Accessories.

All claims under this warranty should be lodged through our website warranty section <https://www.clearviewaccessories.com.au/about/warranty/> with the detail of the fault, proof of purchase, proof of identification and vehicle fitment details where relevant. If your claim is accepted for defects in material or workmanship Clearview will, at its discretion, offer to repair, replace parts, or return and refund.

Our goods come with guarantees that cannot be excluded under the Australian Consumer Law. You are entitled to a replacement or refund for a major failure and for compensation for any other reasonably foreseeable loss or damage. You are also entitled to have the goods repaired or replaced if the goods fail to be of acceptable quality and the failure does not amount to a major failure. In the event of a minor failure, the company reserves the right to choose to repair or replace the product.

**Clearview Towing Mirrors® | ABN: 59 140 145 393 | 3 Frog Court, Craigieburn VIC 3064  
Phone: (03) 8351 9933 | Email: [info@clearviewaccessories.com.au](mailto:info@clearviewaccessories.com.au)**



**CLEARVIEW**

**CLEARVIEW**<sup>®</sup>  
ACCESSORIES

**Head Office**

3 Frog Court, Craigieburn  
VIC 3064, Australia  
(03) 8351 9933

**QLD Office**

Unit 1/49 Doherty Street, Brendale  
QLD 4500, Australia  
(07) 3204 7693

[info@clearviewaccessories.com.au](mailto:info@clearviewaccessories.com.au)

[clearviewaccessories.com.au](http://clearviewaccessories.com.au)