



TOYOTA LANDCRUISER 76/78 SERIES

**FACELIFT
SEPT 2023+**

**TOWING MIRRORS
INSTALLATION GUIDE**

VERSION 2.1

Thank you for choosing Clearview Accessories®

When it comes to road safety, having full visibility of your vehicle and your caravan, trailer or horse float is paramount. Clearview Towing Mirrors extend your field of vision when towing, changing lanes or reversing, to help see you to your destination safely. From Cape York's Telegraph Track to the Gibb River Road, Clearview Towing Mirrors are purpose-built tough for Australian conditions!

Clearview Accessories began in 2006, as a family run business owned by entrepreneur, Mike Cowan and his son-in-law, Jay Praag. In the years that followed, Mike and Jay turned their small family business with three full-time employees, into one of Australia's most respected 4WD and Touring Brands.

With a strong passion for the automotive industry, quality design and discipline in professional workmanship, our trust is built within our values of creating high quality ADR compliant designs.

From humble beginnings, Clearview Accessories has grown and today manufactures a range of unique, quality products for your next off-road adventure!

Contact us:

Clearview Accessories,

3 Frog Court, Craigieburn VIC 3064

Phone: (03) 8351 9933

Email: info@clearviewaccessories.com.au

Website: clearviewaccessories.com.au

Find us on social media



facebook.com/clearviewaccessories



instagram.com/clearviewaccessories



youtube.com/clearviewaccessories

Due to Clearview's Continuous Improvement Program, information may change without notice. Clearview takes no responsibility for the result of incorrect use of these installation instructions.

Introduction	2
Getting Started	4
Before You Start	5
Fitting Instructions	7-19
Mirror Dimensions	20
Maintaining your mirrors	21
FAQ	22
Troubleshooting	23-24
Warranty	25-26
Our Range	27

Clearview mirrors are direct replacement mirrors that mount securely in the same position as your original mirrors.

What's in the box



**For illustrative purposes only*

- 1 x Left-hand side mirror & base
- 1 x Right-hand side mirror & base
- 1 x Installation guide
- 1 x Mirror Fixing Kit

NB: For mirrors selected with any electric features and/or hard-wiring required, if applicable, may also come with:

- 1 x Electric Mirror Wiring + Control Switch
- 1 x Indicator Wiring Kit
- 1 x Powerfold Wiring Kit + Switch Panel

If anything is missing, or damaged, please do not install your new mirrors and contact us on (03) 8351 9933 or via: info@clearviewaccessories.com.au

Tools Required:

- 1/4" Ratchet w/ 8mm + 10mm Sockets
- Drill with a 3mm & 9.5mm drill bit
- Step Drill Bit (Using the 3mm & 9.5mm)
- Philips Head Screwdriver
- Flat Screwdriver
- Non-marring Trim Removal Tool/s
- Silicone Gasket Sealant - Black
- Plastic Wire Feeder
- Centre punch
- Masking tape
- Standard Ruler (or Measuring Tape)
- Fishing wire
- Diagonal pliers/Side cutters

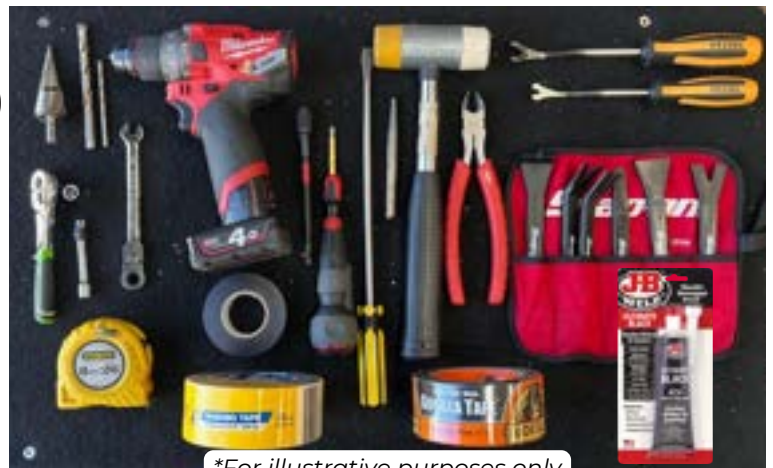

**For illustrative purposes only*

Whilst our mirrors can be installed by one person, the process is quicker and easier when an additional person is available to hold the mirror into position.

IMPORTANT

A qualified Auto-Electrician is required for the installation of all electrical wiring.



CAUTION



WARNING

- Read through the fitting instructions before installation of Clearview Accessories.
- Always install the accessory following the fitting instructions. Failure to do so may cause damage to the vehicle or the accessory and will void your warranty.
- Ensure all packaging materials are recycled and/or disposed of in accordance with local regulations.
- It is always recommended that this accessory is fitted by a qualified technician.
- Safely store and protect any removed vehicle components.
- Ensure all bare metal surfaces are protected using Automotive Bare Metal Primer and touch-up paint.
- Remove all metal swarf and dust from all vehicle surfaces if the surface is used for accessory installation.



POWER FOLD

WARNING

DO NOT UNFOLD MANUALLY

If your mirror is equipped with Power Fold. In some cases, the mirror head may be loose before installation as the mirror head needs to be electrically folded and unfolded for a minimum of cycles on its first use to synchronise.

Please refrain from folding the mirror MANUALLY as it can reduce the life span of the product.

- **NB:** This mirror is designed to be manually folded upon impact as a safety feature.



PUDDLE LIGHT

COURTESY / PUDDLE LIGHT

Please understand that every car and every model is different and that some vehicles have different wiring options than other vehicles. We do not know the exact wiring configuration of your vehicle.

If you require the use of the courtesy/puddle light function, you will require the assistance of an Auto Electrician.

- Clearview Accessories does NOT provide this service unless it's a standard function on the vehicle.

NB: IF HARD WIRING: ORANGE WIRE: NEGATIVE (-) | GREY WIRE: POSITIVE (+)

IMPORTANT

A qualified Auto-Electrician is required for the installation of all electrical wiring.



Your adventure awaits...
Let's begin!

IMPORTANT

A **qualified Auto-Electrician** is required for the installation of all electrical wiring.

IF MIRRORS ARE MANUAL FOLD:

- **With Electric Adjust:** Disregard Powerfold wiring only, ALL other steps apply; OR
- **Without Electric Adjust:** Disregard STEP 7.

Step 1

Prepare vehicle

Place transmission into PARK position with handbrake ON.

- Ensure all windows are UP.
- Turn ignition OFF.

IMPORTANT

Ensure windows are not lowered to allow access behind and around the window track. This will help in further steps with mounting of mirror base and routing of wires where applicable.

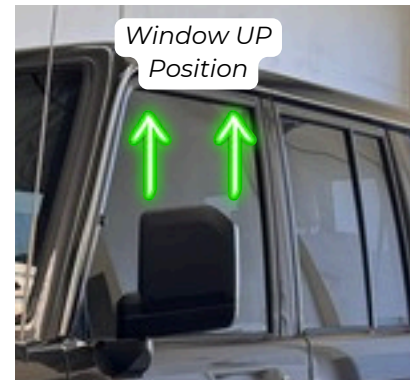

Step 2

Remove door trim, caps and screws



Take extra care by gently removing the Square caps from the door handles. Use a plastic trim remover tool (or a very thin flat screwdriver) to pry the piece back, then use a Phillips screwdriver to remove the screws securing the trim to the door.

- **NB:** You do not need to take the door trim off entirely for this step.

Step 3

Remove door latch



Remove the Phillips head screw securing the door latch, then carefully proceed to remove the Door Latch and the Power Window Switch Panel using a plastic trim removal tool.

- Unplug the wiring connector underneath the power window switch panel.

Step 4

Remove door trim

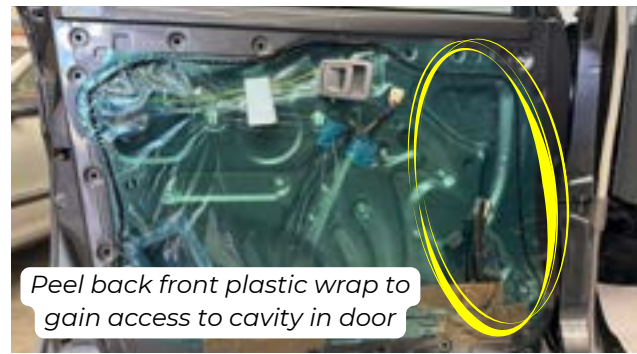

Pry back the door trim using a plastic trim removal tool. Start from the bottom corner, then work your way along the panel to pry back the rest of the door trim.

- Route the door latch and door wire harness via holes in the door trim to complete the removal of the door trim panel as shown.

Step 5

Remove OEM mirror outer trim



Use a plastic trim removal tool to gently pry and remove the outer mirror trim cover.

- Ensure not to break the retaining clips as shown in example.

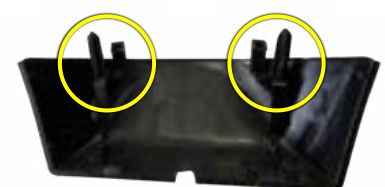

Step 6

Remove the OEM mirrors



Use an **8mm socket** with an extension to remove the factory mirror mounting bolts and detach the OEM mirror from the door.

IF MIRRORS ARE MANUAL FOLD:

- **With Electric Mirror Adjust:** Disregard Powerfold wiring steps only, the following wiring steps apply - Proceed to **STEP 7**.
- **Without Powerfold; AND/OR Without Electric Mirror Adjust:** **SKIP TO STEP 8.**

Step 7

Disconnect mirror wiring plug



Use a small precision flat-blade screwdriver to help release the retaining tab and disconnect the wiring plugs as demonstrated.



HANDY TIP: Keep your original OEM mirrors as a backup in the event something unforeseen happens to your Clearview Mirrors, necessitating the need to return it to Clearview for repairs.

Step 8

Prepare the Mounting Base

8.1 Place the Clearview Towing Mirrors on a sturdy bench. We recommend placing down some cardboard or non-marking material on the bench to avoid scuffing the mirrors.



Place towing mirrors on a sturdy bench

- Locate the rubber clip on the seal supplied, then clip in on the upper half of the lower base, if required (No Land Cruiser Badge - refer below badge tips, if applicable).



Place rubber clip on seal
*if no Landcruiser badge

NB: Do not use clip if placing over Land Cruiser badge

HANDY TIP:

- If the '**Land Cruiser' badge** is on the door and below the mirror, remove the rubber insert pad.
- If the '**GXL' badge** is below the mirror, remove the badge using a fishing wire and relocate it.

REPEAT this step for both sides.



**Optional: If GXL badge is in the way of mounting mirror, you may remove by carefully using fishing wire and then relocate accordingly to your desired position etc.*

WARNING:

FAILURE TO ENSURE WIRING IS CONNECTED CORRECTLY CAN PRESENT FAULTS AND/OR NO ELECTRICAL FUNCTIONALITY ETC.

Step 9

Prepare the Exterior

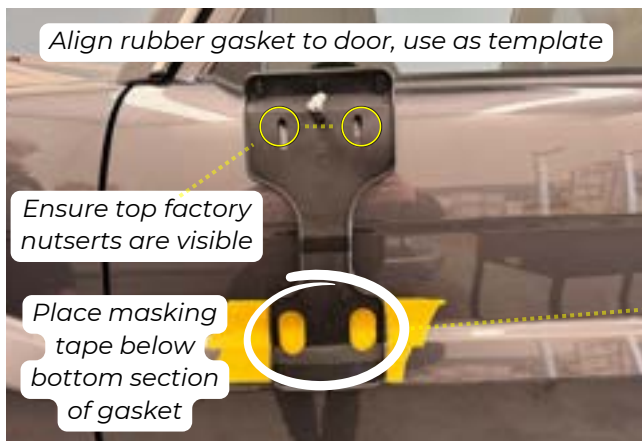

9.1 Use the rubber gasket supplied in kit to line up and create a template on the door.

- Align rubber gasket so the top 2 mounting points (factory nutserts) are visible.
- Lay down 2 strips of masking tape to the door underneath lower section of rubber gasket.
- Mark the 2 centre points ' + ' and then use a centre punch to mark for drilling.



9.2 Drill the 2 x pilot holes as shown, then use a step drill to drill the 2 x 8mm new bottom holes.

- Ensure to apply black silicone gasket sealant to the 2 new bottom holes.



9.3 Locate the 10mm hex phillips screws bolts and the stainless-steel plates supplied in the kit.

- Ensure surface on the inner-door skin is cleaned before securing plate in to position.

Step 10

Prepare The Exterior

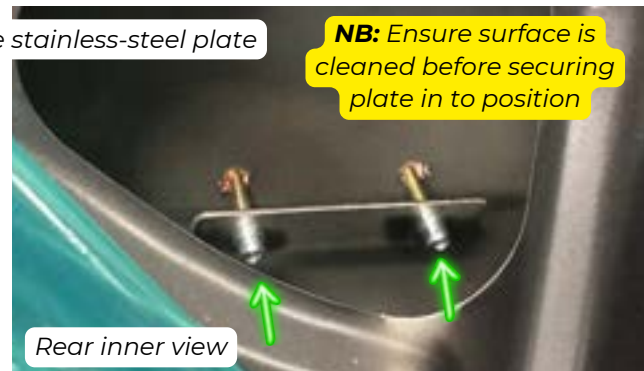
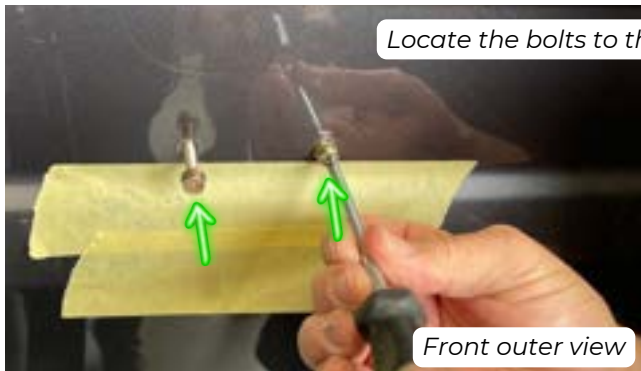

- 10.1** Attach the stainless-steel plate to the door, lining up the holes to the thread.
- Locate the bolts to the stainless-steel plate and push plate firmly into the car door, test that you can locate the screws, and ensure to avoid cross-threading the screws.



- 10.2** Lay down some strips of masking tape around the holes as shown in example.
- Carefully screw in the hardware just to help secure plate onto door-skin.



- 10.3** Firmly press and secure plate on the inner-door skin.
- Remove the hardware from the stainless-steel plate.

Step 11

Prepare The Exterior

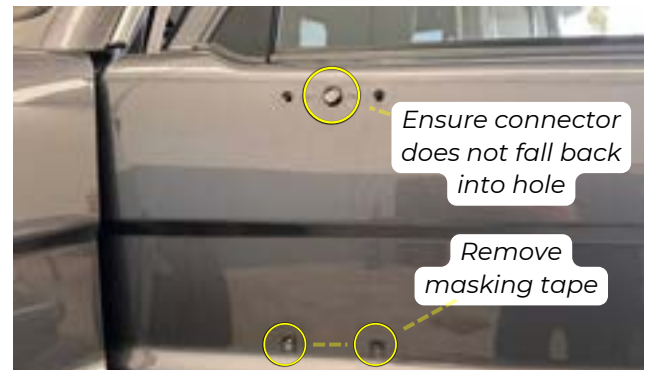

11.1 Ensure to apply black silicone gasket sealant to the 2 x holes.

- Remove masking tape from the door



11.2 Locate the factory mirror plug and bring it inside the door as shown.

- IF Manual Fold mirror with no electric mirror adjust AND/OR no powerfold, SKIP THIS STEP.



11.3 Carefully feed the wiring through the top centre hole as demonstrated. (Disregard wiring step if no electric mirror adjust AND/OR no powerfold)

- Align the Clearview Towing Mirror to the vehicle door.
- Ensure the mirror gasket is seated correctly and no wiring is trapped under gasket.

NB: It helps to have a second set of hands when commencing this step, and have someone holding the mirror for ease of installation.

Step 12

Prepare The Exterior



12.1 Using the long bolts supplied in the kit, start with the 2 x 10mm hex phillips sems bolts and screw in by hand just enough to hold the mirror to the door.

- With the 2 x bottom holes, use 2 x 10mm hex phillips sems bolts in the kit to screw in using the offset cup washers into the bottom two holes.
- Do not over-tighten or cross-thread the bolts.

12.2 With the mirror secure in place, begin to cover the bolts with the caps (check the rear of caps for correct orientation).

- Locate caps supplied in kit, gently push into the mounting base hole and clip it into place.
- **REPEAT** for the remaining mounting holes.

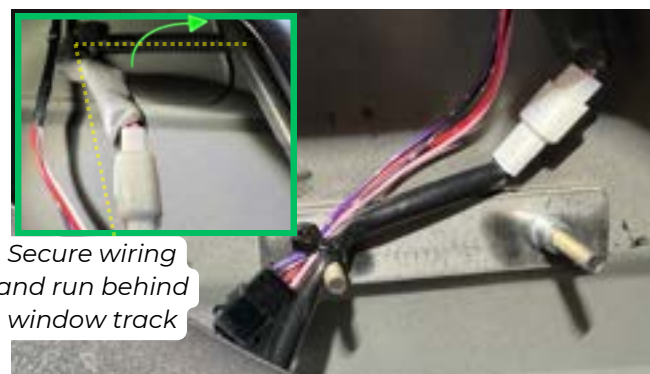
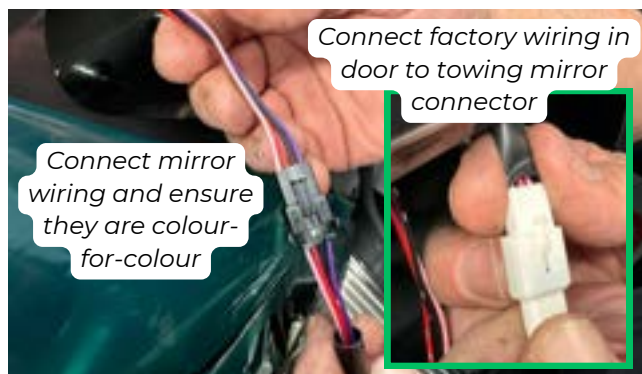

12.3 Connect the towing mirror wiring, ensure the wires are matched colour-for-colour.

- Ensure factory wiring is then connected to the towing mirror connector.
- Secure wiring as demonstrated and ensure wiring is run behind the window track.

REPEAT all these instructions for your Passenger LEFT-HAND SIDE (LHS) Clearview Towing Mirror.

Step 13

Running the switch panel wiring

NB: If towing mirrors are optioned with Powerfold, the factory switch panel is to be replaced with the new electric kit supplied

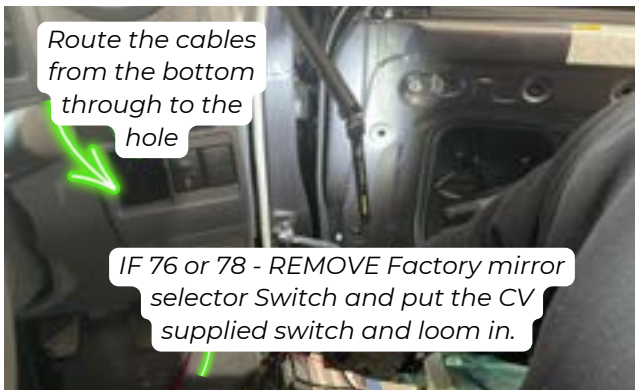

Substitute the blank factory switch panels with the following:

- The regular-sized blank panel is suitable with the Clearview Powerfold switch.
- The larger-sized blank panel is suitable for the Clearview Mirror Actuator switch
- Route the cables through each of the panels by using a plastic wire feeder.

Step 14

Running the Powerfold and/or Mirror Actuator wires behind dash

Route the Powerfold and/or Mirror actuator wires behind the dash panel.

- Take the **'R' wire** through to the grommet in the Driver's door.
- Route the **'L' wire** over the transmission tunnel, and in through to the grommet in the Passenger door.

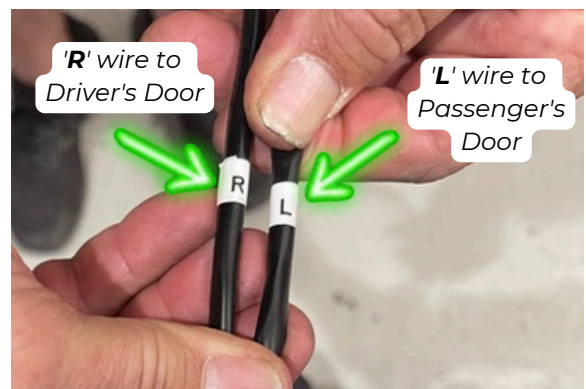

NB: When routing the Powerfold and Mirror actuator wiring:

- The LONGER cable is to the LEFT-HAND SIDE (LHS) rubber grommet in the door; AND
- The SHORTER cable goes through the RIGHT-HAND SIDE (RHS) rubber grommet in the door.

Step 15

Connect the wiring and connectors

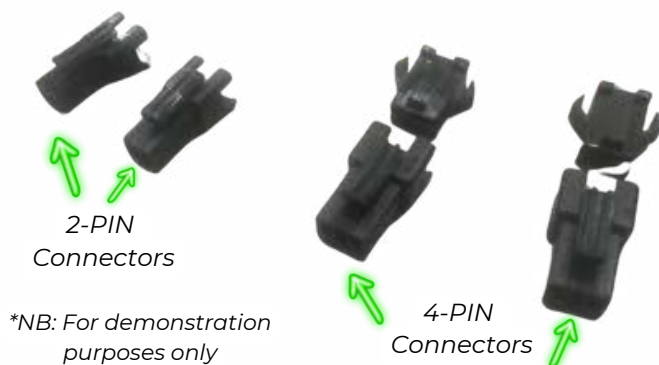

Connect Mirror Actuator Wires to 4-PIN connector **if applicable*

Important to match colour for colour when plugged in



15.1 Electric Mirror Adjust (if applicable):

Using the 4-PIN Connector Plugs supplied:

- Connect all the mirror actuator wires (**RED/BLACK/PURPLE/PINK**) to the corresponding plug, colour for colour.

NB: Does not matter which order they go in, however, important they are matched colour for colour when plugged together.

IMPORTANT

Ensure the Powerfold and Mirror Actuator wires are **hard-wired to Accessories Power** using a fuse tap in kit, or cable joiner etc.

Step 16

Connect Clearview Switch Panel to Dash

Once the Powerfold and/or Mirror Actuator wiring has been correctly run behind the dash:

- Connect the Clearview Powerfold Switch Panel and/or the Clearview Mirror Actuator Switch Panel to their corresponding connectors, then mount to dash.
- The larger-sized panel is for the Mirror Actuator Switch + Powerfold.

NB: Non-Powerfold versions will use the factory switch panel



IF MIRRORS ARE MANUAL FOLD:

- **With Electric Mirror Adjust:** Disregard Powerfold wiring only, ALL other wiring steps apply; OR
- **Without Electric Mirror Adjust:** **SKIP TO STEP 18.**

Step 17

Connecting the Wiring

13.1 Locate the wiring from your Clearview Towing Mirror that was fed through to the interior of the Driver's Side door (RHS).

- Re-configure the wiring where necessary, ensuring that it is connected correctly.
- If mirrors have Powerfold, connect the Powerfold module/Circuit breaker to the corresponding **LIGHT BLUE/YELLOW** wiring.

NB: If the wires are not connected or secured correctly, the features of the mirror will not work.

Wiring Reference, if applicable:

- Mirror Actuator Wires: **RED/BLACK/PURPLE/PINK**
- Powerfold Wires: **LIGHT BLUE/YELLOW**

13.2 Once all wiring is connected, secure neatly to the section highlighted on the inner door skin.

- If mirrors have Powerfold, ensure the circuit breaker is secured to the round tubular intrusion bar in the door, you may use cable ties to help secure this in position.

REPEAT all these instructions for your Passenger LEFT-HAND SIDE (LHS) Clearview Towing Mirror.

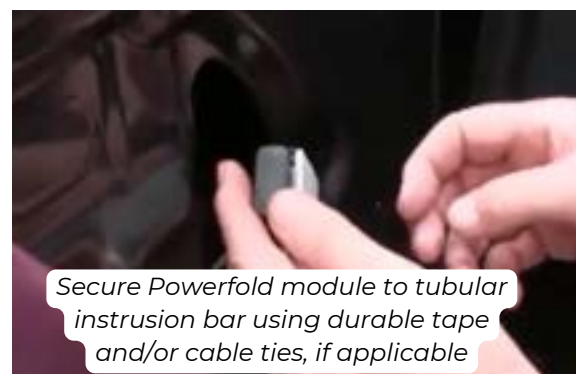
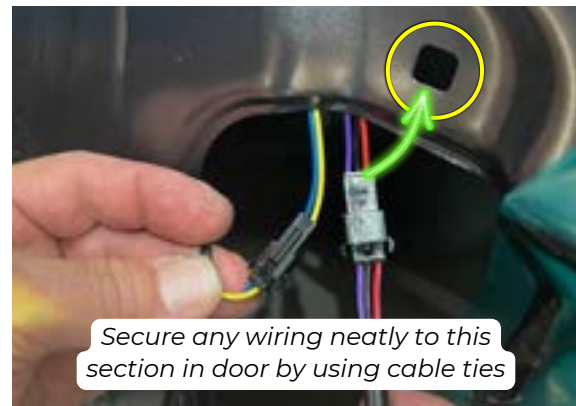

WARNING:

PLEASE ENSURE ALL WIRING IS TUCKED AWAY FROM THE WINDOW TRACK ROUTE ALL WIRING BEHIND THE FRONT WINDOW TRACK AND UNDER THE DOOR BLADE WHICH SWINGS IN AND OUT WHEN CLOSING AND OPENING THE DOOR.

Step 18

Test and Operate Mirror Functions



Begin testing to ensure that your Clearview Mirrors are operating correctly.

- For Manual Mirrors - manually set and adjust your mirrors to your desired position etc.
- Test your mirror functionality to ensure they run the correct way - UP, DOWN, LEFT, RIGHT.
- Test Powerfold IN, OUT etc - if applicable.

NB: Good to test the front windows functionality to ensure no trapped wires in window track etc.

Step 19

Reassemble door trim

Secure the door trims into their original position.

REPEAT Steps 1-4 in REVERSE order.



Congratulations! You have now fully installed your new Clearview Towing Mirrors and are ready for your next adventure!



Clearview Compact

Non-Extended Standard Driving Position



Extended Towing Position



Fully Extended Towing Position

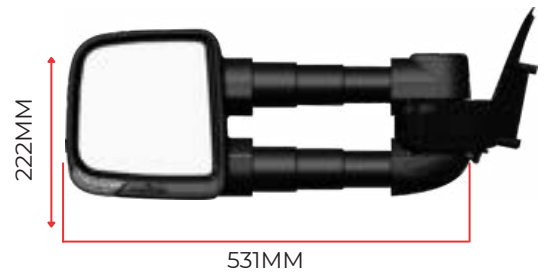

Clearview Next Gen

Non-Extended Standard Driving Position



Extended Towing Position

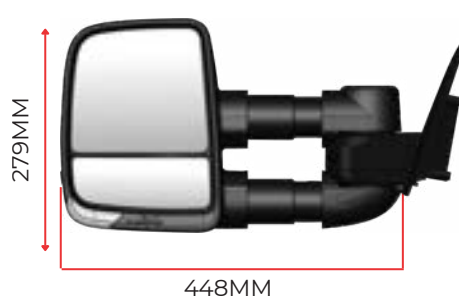

Fully Extended Towing Position

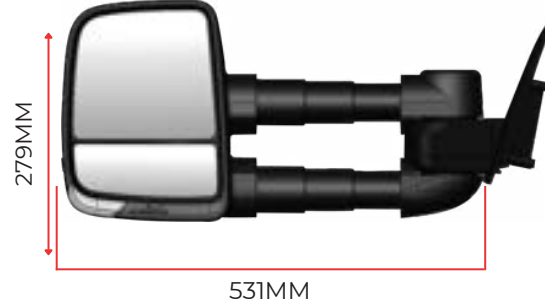

Maintaining Powder Coated Surfaces

Whilst powder coating is a lot more durable, and longer lasting than paint, it can still be affected by dust, dirt, salt water and constant exposure to the weather. For this reason, no protective powder coating is completely maintenance-free. With the right maintenance, you can increase the life of the finish of your powder-coated surfaces:

- Harsh pressure washers, chemicals and solvents can damage the powder coating. Once damaged, the surface is a lot more vulnerable to fading and failure.
- We recommend regularly inspecting your powder coat and wiping any dust off with a soft cloth. Clean, good-quality microfibre cloths are recommended.
- We recommend regular washing with highly diluted mild soap and water. Use a soft towel to gently clean. Rinse and dry with another soft drying towel/chamois.
- If your powder coat is losing its shine, you can apply a thin layer of high-grade non-abrasive car wax after it's been cleaned. Wipe all the wax off once it's dried and the powder coat should look like new again! Use a car wax brand that contains a UV blocker or UV inhibitors. Do not use compound-type waxes as they contain abrasives that can harm the powder coating.
- It's important in coastal areas to regularly clean any powder-coated surfaces as salt will stick to the coating, dulling its appearance. This can leave your powder-coated surface looking chalky.
- We don't recommend paint touch-ups to cover imperfections as paint won't adhere to powder-coated surfaces. A local professional can quote to repair the powder coating.

How do I maintain my Powerfold mirrors?

Under regular Powerfold operation, there shouldn't be any maintenance required, however, if it is regularly used off-road, then the mirrors may need to be maintained every 6-12 months.

- This maintenance involves pulling the mirror into the fully extended position and applying dry lubricant on the arms, not the arm covers.

Maintaining your Chrome Mirrors

The chrome finish used on our mirror heads is a chrome-plated plastic, which provides the appearance and feel of real chrome, in a more lightweight and cost-effective material. Weather conditions, how often they are washed and how close to the ocean you live, all play a role in the longevity of the chrome finish.

- Automatic car washes that use bristle brushes or acidic preparations can damage your chrome
- Salt and de-icers will surface pit chrome and extra care will be required with more frequent washes to remove residue.
- We recommend washing them weekly with mild soap and water, steering clear of ammonia-based or acid solutions.
- Clean, good-quality microfibre cloths are recommended to wipe down the chrome surface and prevent water stains from forming
- An occasional polish with a non-abrasive chrome polish will help bring your chrome back to its original shine!

NB: If chrome isn't properly maintained, it can develop pitting from corrosion or lose its attractive shine. We recommend **Autosol Metal Polish** and **Autosol Metal Life Saver**.

Can I install Clearview mirrors myself?

Yes! Depending on the complexity of the installation, Clearview mirrors are extremely easy to install and mount to the vehicle's original OEM mirror mounts. Depending on the vehicle's current mirror options, Clearview mirrors include plug and play wiring looms. Instructional videos are also available on our website (clearviewaccessories.com.au) in the "HOW TO" section. Clearview recommends that any installation requiring hard wiring be done by a licensed auto electrician.

What is the fitting time?

Depending on the complexity of the installation, a dealer should be able to install the mirrors in approximately 15 minutes per side of the vehicle. Installation requiring special fitting and/or hard wiring will require longer fitting times (eg: Camera and electric wiring kits). Note: The 70 Series mirrors with electrics are more complex and will take more time than a 'normal' vehicle fitting. Please contact Clearview mirrors if you have any questions about fitting or wiring.

Are the telescopic arms electric?

No. The telescopic arms are extended manually. Clearview Mirrors will only fold against the vehicle electronically provided we make that model in Power Fold.

Can I retrofit the original mirror base to the Next Gen or Compact mirrors?

No. The cost of converting the mirrors to suit the new models is not worth it. We recommend either selling your Original mirrors privately or through the "Pre-Loved" section (Within the "Shop" menu category) of our website and purchasing the new Next Gen or Compact mirrors brand new.

Can I add an indicator later if I didn't order the mirrors with an indicator?

Yes, you can. But it comes at a greater expense than if you were to order the mirrors with indicators. Installation to the mirror head will require longer time and more parts to dismantle.

Are spare parts available?

Yes. We have a list of spare parts for all our mirrors on our website. Our dealers also have a list of all our spare parts.. If you cannot find the parts that you require, please contact us or any of our dealers to assist you with your inquiry

How do I maintain my mirrors?

We recommend that Clearview Mirrors are lubricated every 6-12 months, when the arms feel stiff during use, or after any big trip to ensure longevity of your Clearview Towing Mirrors!

This maintenance includes pulling the mirror into the fully extended position and applying the dry lubricant on the arms. We recommend using WD-40 Specialist Dry Lubricate.



Avoid any waxy lubricants as they can attract dirt and grit.

**SCAN THE QR CODE
AND VIEW OUR VIDEO
DEMONSTRATING**

How to lubricate the arms
on Clearview Towing Mirrors



I have just installed my new Powerfold mirrors and the mirror heads appear 'loose'/'floppy'.

After the mirrors are installed, they need to be cycled a few times. This will allow all the internal mechanisms to set and find the proper positions.

- If the mirror head is still loose/floppy after they're cycled, please contact Clearview Technical Support.

I have installed my Powerfold Mirrors and have noticed that the Passenger's side mirror is closer to the vehicle compared to the Driver's side; Is this normal?

This is entirely normal. In most vehicles, the mirror housings are angled differently between the driver's and passenger's sides.

- This is because when you sit in the car, the mirrors are positioned from/to the driver's position (which is off-centre), so generally, the passenger side mirrors are closer to the vehicle body to allow you to have the same field of vision in the mirror.

One of my Powerfold Mirrors folds/opens quicker than the other one; Is this normal?

Generally, the passenger mirror will fold/open quicker, as it is closer to the vehicle body and therefore travels a shorter distance compared to the driver's side mirror.

(Refer to the previous question in regards to why the mirrors are angled differently.)

My mirrors have been knocked out of Driving Position; how do I fix it?

Press the powerfold switch once. This should initiate the powerfolding motors and the mirrors should start folding inwards. Wait until the mirrors are fully folded in and have stopped moving, then press the powerfold switch again. This should now bring your mirrors back out to normal driving position. Check and see if the mirrors are locked into position firmly. If the mirror is not returning to its normal position, please contact Clearview Technical Support.

- **NB:** *The Powerfold mirrors can fold manually, however, the manual fold mechanism is only designed as a safety feature. Throughout the lifespan of the product, manual folding will occur, such as people walking into them or accidentally bumping them. The internal mechanisms are designed to withstand this accidental manual folding during normal usage. It is not recommended for the mirrors to be manually folded constantly, as it will prematurely wear out the internal folding mechanisms and reduce the lifespan of the product.*

My mirror was knocked out of the driving position. When I cycled them, there is a clicking sound and the mirror appears to have “jumped”; Are my mirrors damaged?

When the Powerfold mirror is being cycled to find its original driving position, it will “jump” back into position and make an audible click sound when mechanisms realign. Once the mirrors have found the original position and have been cycled, check for looseness and mirror movement. If they feel firm, then the mirrors have not been damaged. If they still feel loose, please contact Clearview Technical Support.

Why don't my mirrors fold all the way in/out when I press the switch?

The circuit breaker inside the mirror activates when the electrical current increases due to resistance. If the mirror stops before it reaches the folded in/out position, that means something is adding resistance while the mirrors are folding, hence activating the circuit breaker before it has reached the desired position. Please contact Clearview Technical Support.

Clearview Towing Mirrors® are full replacement towing mirrors designed and manufactured to the highest quality standards to replace your vehicle's standard side mirrors. We stand behind our Next Gen and Compact Towing Mirrors with a 3-year Manufacturer's Warranty and 7-year Parts Warranty. We stand behind our Original Towing Mirrors and Classic Towing Mirrors with a 12-Month Manufacturer's Warranty and 3-year Parts Warranty

Please ensure that your receipt is kept in a safe place. A receipt will be required to make a warranty claim on any Clearview product. If we determine that a Clearview Towing Mirror is defective in materials or workmanship during the Warranty, we will either repair or replace the product. Repair or replacement is solely at the discretion of Clearview Accessories.

Please ensure that you fit the Clearview products in accordance with the product information provided and all relevant vehicle safety and compliance laws; and use the Clearview product for the purpose for which it was originally designed. This warranty does not apply to failure or damage caused by incorrect or faulty fitment, accidental or intentional damage, alteration, acts of nature, vandalism, collision, road hazards or adverse conditions, misuse, abuse or neglect of the Clearview product, including improper repair or maintenance or failing to repair and maintain the product, failure of other products, operation of the product outside of its environmental or technical specifications, or repair or modification carried out by anyone other than Clearview Accessories®. No charges will be accepted for external labour or materials without the prior advice or clearance from Clearview claims team. Clearview Accessories® warranty does not cover any scratches or chips.

Clearview Towing Mirrors are designed to be vehicle-specific. When purchasing Clearview Towing Mirrors, carefully select your product according to ADR compliance laws and vehicle specifications. Clearview Towing Mirrors are not designed to be modified for convenient use on alternative vehicles. Alteration, modification, or manipulation of our products will void all warranty with Clearview Accessories.

All claims under this warranty should be lodged through our website warranty section <https://www.clearviewaccessories.com.au/about/warranty/> with the detail of the fault, proof of purchase, proof of identification and vehicle fitment details where relevant. If your claim is accepted for defects in material or workmanship Clearview will, at its discretion, offer to repair, replace parts, or return and refund.

Our goods come with guarantees that cannot be excluded under the Australian Consumer Law. You are entitled to a replacement or refund for a major failure and for compensation for any other reasonably foreseeable loss or damage. You are also entitled to have the goods repaired or replaced if the goods fail to be of acceptable quality and the failure does not amount to a major failure. In the event of a minor failure, the company reserves the right to choose to repair or replace the product.

Clearview Accessories | ABN: 59 140 145 393 | 3 Frog Court, Craigieburn VIC 3064
Ph: (03) 8351 9933 | Email: info@clearviewaccessories.com.au

Towing Mirrors

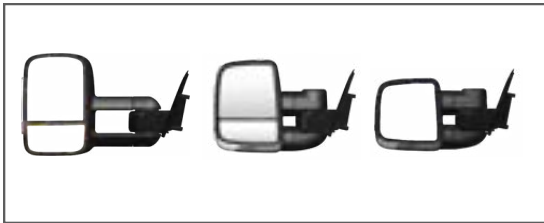

Power Boards



Rock Tamers



Tyre Spider



Easy Slides



Power Slides



Expanda Slides



Fridge Cage



Pantry

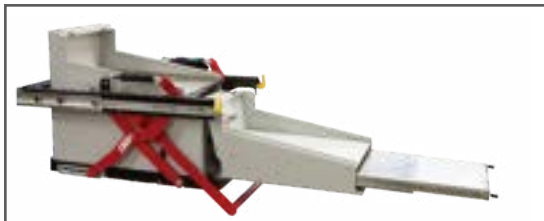

Cutlery Set



Clip on Trays

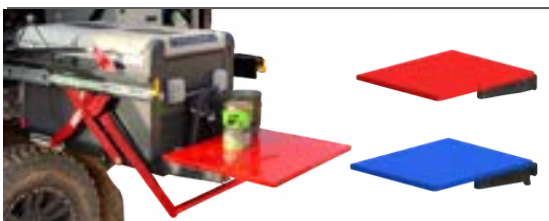

Cable Saver

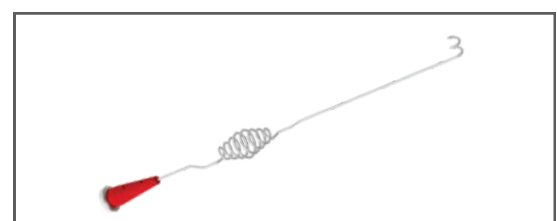



Head Office

3 Frog Court, Craigieburn
VIC 3064, Australia
(03) 8351 9933

QLD Office

Unit 1/49 Doherty Street, Brendale
QLD 4500, Australia
(07) 3204 7693

info@clearviewaccessories.com.au

clearviewaccessories.com.au

