



TOYOTA HILUX

JULY 2015 - 2025

TOYOTA FORTUNER

2015 - 2026

TOWING MIRRORS INSTALLATION GUIDE

VERSION 2.6

Thank you for choosing Clearview Accessories®

When it comes to road safety, having full visibility of your vehicle and your caravan, trailer or horse float is paramount. Clearview Towing Mirrors extend your field of vision when towing, changing lanes or reversing, to help see you to your destination safely. From Cape York's Telegraph Track to the Gibb River Road, Clearview Towing Mirrors are purpose-built tough for Australian conditions!

Clearview Accessories began in 2006, as a family-run business owned by entrepreneur, Mike Cowan and his son-in-law, Jay Praag. In the years that followed, Mike and Jay turned their small family business with three full-time employees, into one of Australia's most respected 4WD and Touring Brands.



With a strong passion for the automotive industry, quality design and discipline in professional workmanship, our trust is built within our values of creating high-quality ADR-compliant designs.

From humble beginnings, Clearview Accessories has grown and today manufactures a range of unique, quality products for your next off-road adventure!

Contact us:

Clearview Accessories,
3 Frog Court, Craigieburn VIC 3064
Phone: (03) 8351 9933
Email: info@clearviewaccessories.com.au
Website: clearviewaccessories.com.au

Find us on social media

-  facebook.com/clearviewaccessories
-  instagram.com/clearviewaccessories
-  youtube.com/clearviewaccessories

Due to Clearview's Continuous Improvement Program, information may change without notice. Clearview takes no responsibility for the result of incorrect use of these installation instructions.

Introduction	2
--------------	---

Getting started	4
-----------------	---

Before you start	5
------------------	---

Mirror dimensions	6
-------------------	---

Fitting instructions	7-19
----------------------	------

Maintaining your mirrors	20
--------------------------	----

FAQs	21
------	----

Troubleshooting	22-23
-----------------	-------

Warranty	24
----------	----

Our range	25
-----------	----

Clearview towing mirrors are direct replacement mirrors that mount securely in the same position as your original mirrors.

What's in the box



If you have purchased a camera model mirror: Within the shipping box with the mirror head, you will find a camera bracket kit for your make of vehicle. This kit will contain:

- A. 1 x LH and 1 x RH camera bottom access panels (parts marked/inscribed LH and RH)
- B. 1 x LH and 1 x RH camera brackets (parts marked/inscribed LH and RH)
- C. 4 x camera bracket attaching screws

- 1 x Left-Hand side mirror & base
- 1 x Right-Hand side mirror & base
- 1 x Installation guide
- 1 x Bottom Access Panel (if mirror does not contain 360 camera; OR
- 1 x 360 Camera Kit (if mirror contains 360 Camera feature)

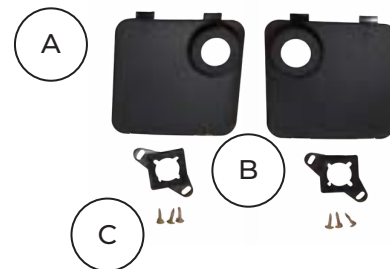

If anything is missing, or damaged, please do not install your new mirrors and contact us on 03 8351 9933 or via: info@clearviewaccessories.com.au

Tools Required:

1. Door Trim Plier Removal
2. Plastic Pry Tool - Narrow & Wide
3. Trim Clip Removal
4. "S" Hook
5. Flat & Phillips head screwdriver
6. Torque Wrench
7. M10 Socket & Phillips head bit driver with DC Gun. (Eg. Makita 12V)
8. Ratchet with M10 Socket head
9. Chalk Marker
10. Cable Ties



Whilst our mirrors can be installed by one person, the process is quicker and easier when an additional person is available to hold the mirror into position.



CAUTION



WARNING

- Read through the fitting instructions before installation of Clearview Accessories.
- Always install the accessory following the fitting instructions. Failure to do so may cause damage to the vehicle or the accessory and will void your warranty.
- Ensure all packaging materials are recycled and/or disposed of in accordance with local regulations.
- It is always recommended that this accessory is fitted by a qualified technician.
- Safely store and protect any removed vehicle components.
- Ensure all bare metal surfaces are protected using Automotive Bare Metal Primer and touch-up paint.
- Remove all metal swarf and dust from all vehicle surfaces if the surface is used for accessory installation.
- Your vehicle may be fitted with the Active Park Assist feature. You should only use this feature with your Towing Mirrors in the fully retracted, driving position.



POWER FOLD

WARNING

DO NOT UNFOLD MANUALLY

If your mirror is equipped with Power Fold. In some cases, the mirror head may be loose before installation as the mirror head needs to be electrically folded and unfolded for a minimum of cycles on its first use to synchronise.

Please refrain from folding the mirror MANUALLY as it can reduce the life span of the product.

- **NB:** This mirror is designed to be manually folded upon impact as a safety feature.

COURTESY/PUDDLE LIGHT

Please understand that every car and every model is different and that some vehicles have different wiring options than other vehicles. We do not know the exact wiring configuration of your vehicle.

If you require the use of the courtesy/puddle light function you will require the assistance of an Auto Electrician.

- Clearview Accessories does NOT provide this service unless it's a standard function on the vehicle.

NB: Where there is an electrical modification of the vehicle, a suitably licenced person should undertake the work.

- IF HARD WIRING: **ORANGE WIRE: NEGATIVE (-) | GREY WIRE: POSITIVE (+)**

Compact Towing Mirrors

Non-Extended Standard Driving Position



Extended Towing Position

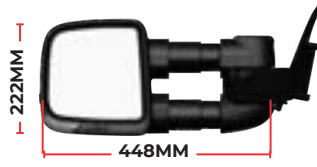

Fully Extended Towing Position

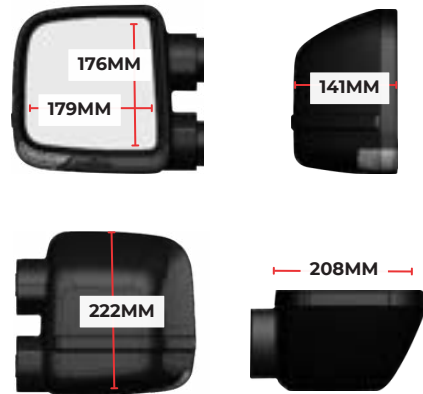
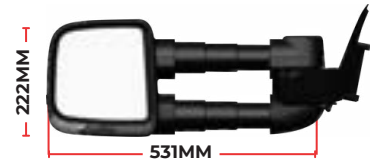

Next Gen Towing Mirrors

Non-Extended Standard Driving Position

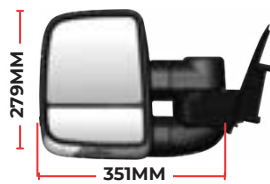

Extended Towing Position

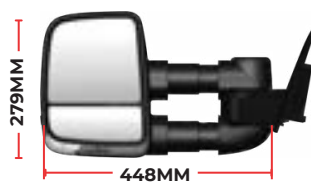

Fully Extended Towing Position

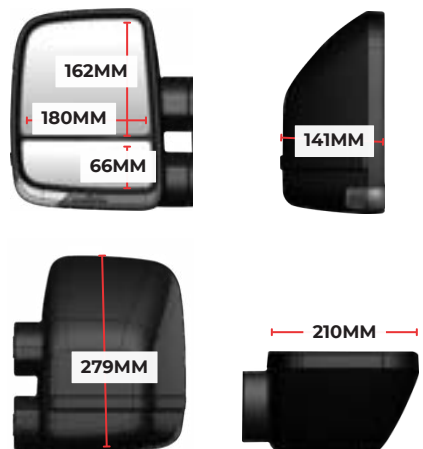
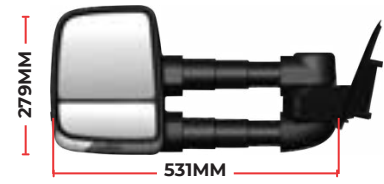



WARNING!

It's important that you disconnect the battery by removing the -ve terminal (disconnect the earth) prior to removing and disconnecting the side mounted mirrors.

- If you remove a mirror to install Clearviews and test it without the circuit being complete, the vehicle may present errors, requiring the need to return the car to the Dealer at your expense to clear the code.



Cover the battery connectors with a fabric cloth to prevent accidental contact with the negative (-) battery terminal.



Step 1

Prepare vehicle:

- 1.1 Place transmission into the PARK position with the handbrake ON.
- 1.2 Turn ignition ON and ensure both front windows are DOWN.
- 1.3 Turn the ignition OFF.



⚠️ WARNING: It's important that you disconnect the battery by removing the -ve terminal (disconnect the earth) prior to removing and disconnecting the side-mounted mirrors.

- If you remove a mirror to install Clearviews and test it without the circuit being complete, the vehicle may present errors, requiring the need to return the car to the Dealer at your expense to clear the code.

Step 2

Remove door trim components:



- 2.1 Use a plastic trim removal tool to carefully remove the quarter panel trim piece, the door latch panel cover AND the armrest trim.
 - The armrest needs to be pried upwards, not outwards.

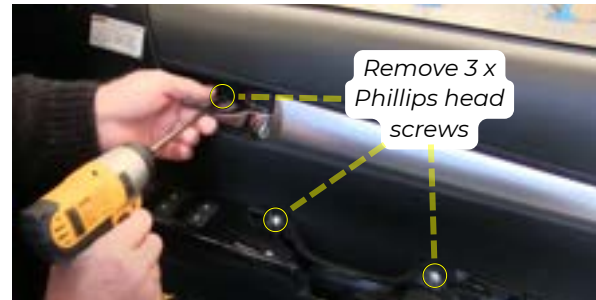

- 2.2 Once the screws are revealed, use a Phillips head screwdriver to remove them and set aside.



HANDY TIP: If you are struggling to get to the two screws where the armrest is, you can remove this by lifting the white plastic tabs located under the panel.

Step 3

Remove door trim:



- 3.1** Carefully remove the door trim by using a non-marring plastic trim tool.
- Begin at the bottom edge of the door trim, then work your way around until the door trim disconnects from the retaining clip mounting points.
- 3.2** Lift the door trim upward and position it onto an 'S' hook, to support the door trim during installation.
- If you don't have a hook, you will need someone to hold the trim to relieve pressure on the wires.

Step 4

Remove the OEM Mirror:

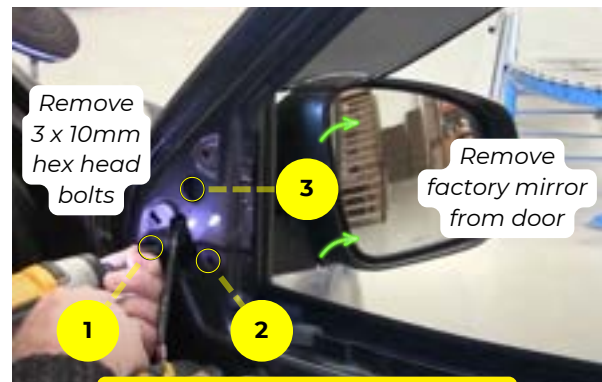

- 4.1** Disconnect the factory mirror wiring plug from the connector as highlighted.
- 4.2** Remove the 3 x 10mm hex head bolts to free the factory mirror from the door, ensure wiring loom is fed outward through the quarter panel.
- Re-fasten the 3 x 10mm hex head bolts back to the factory mirror to retain and set aside.



HANDY TIP: Keep your original OEM mirrors as back up should something happen to one of your Clearview Mirrors, necessitating the need to return it to us for repairs.

Step 5

Attach Towing Mirrors to the vehicle:

5.1 Align the Towing Mirror Base to the factory mounting position on the door, and feed the wiring through the hole before mounting it to the door by using the 10mm bolts.

- Ensure that no wires are trapped.

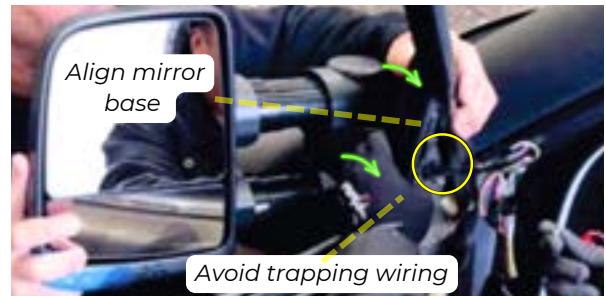

5.2 Secure the 3 x 10mm bolts with the 1/4" drive ratchet.

- Hand-start the bolt screws, to avoid cross-threading of the screws.
- Ensure not to over-tighten the bolts as this may do damage to the base or bolts etc.
- Tighten to torque spec of approx. 12 N·m.

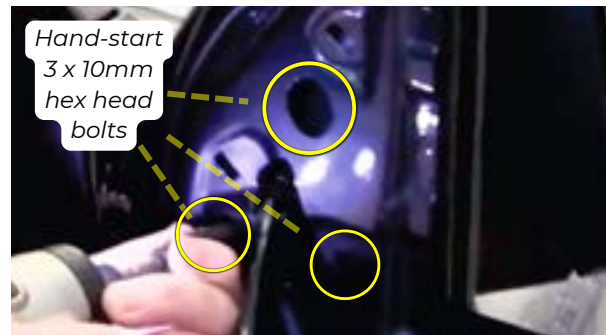

5.3 Re-connect the wiring from your Clearview mirror into the OEM connector on the door.



IMPORTANT

- If the mirrors do not have the 360° camera feature, SKIP to **STEP 12**.
- If the mirrors contains the 360° feature, please follow the next steps.

Step 6

Remove OEM 360° cameras from the OEM mirrors:



HANDY TIP: Place the OEM mirrors on a sturdy bench, we recommend placing down some cardboard or non-marking material on the bench to avoid scuffing the mirrors.

6.1 Locate the lens of your 360° Camera at the bottom of the OEM Mirror.

- With a white pencil, gently create a line, from the glass side of the mirror to the middle of the camera.

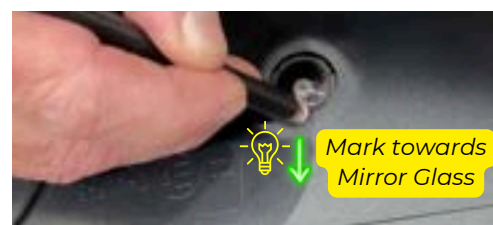

6.2 Using a non-marring plastic trim removal tool, gently remove the mirror's exterior plastic cover.

- Start from the side of the indicator, then gently work your way along the trim, as there may be some clips within the middle.



6.3 Separate the exterior mirror cover, and set aside.



6.4 Carefully remove the two screws as shown.



6.5 Gently pry back and remove the mirror glass from the mirror actuator, be mindful of any clips or wiring beneath the mirror.

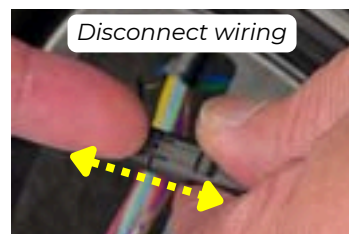

6.6 Disconnect the mirror wiring for easy access.

6.7 Locate the tab as pictured, and it will loosen the outer mirror components.



6.8 Locate the green 360° camera wiring connector, then carefully use a mini flat screwdriver to help unplug the connector.

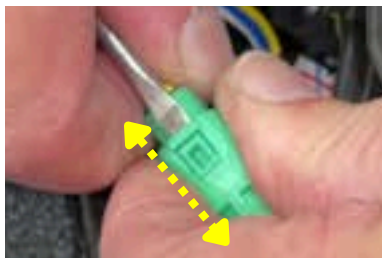

6.9 Locate the Camera Bracket and remove the two screws keeping it in place.



6.10 Disconnect the wiring connector located on the bottom of the Camera bracket.

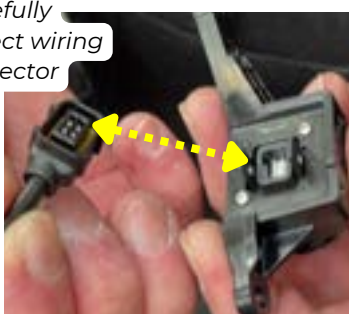

6.11 Remove your Camera from your bracket, by removing the two mini screws. Ensure the wiring is still attached.



TIP: DO NOT mix up the 360° cameras when removing them from the OEM mirror.

- **LEFT Camera** to be installed in the LEFT-HAND SIDE (LHS) Clearview Towing Mirror; AND
- **RIGHT Camera** to be installed in the RIGHT-HAND SIDE (RHS) Clearview Towing Mirror.

Step 7

Fitment of 360° Camera & Bottom Access Panel:

7.1 Opening in mirror housing should be clear for fitment of the camera bottom access panel and to provide access to the camera wiring plug.



7.2 Remove parts from the camera bracket kit.

- Within the shipping box with the mirror head, you will find a camera bracket kit for your make of vehicle.

Camera bracket kits contain:

- 1 x LEFT-HAND and 1 x RIGHT-HAND 360° camera bottom access panels
- 1 x LEFT-HAND and 1 x RIGHT-HAND 360° camera brackets
- 4 x camera bracket attaching screws

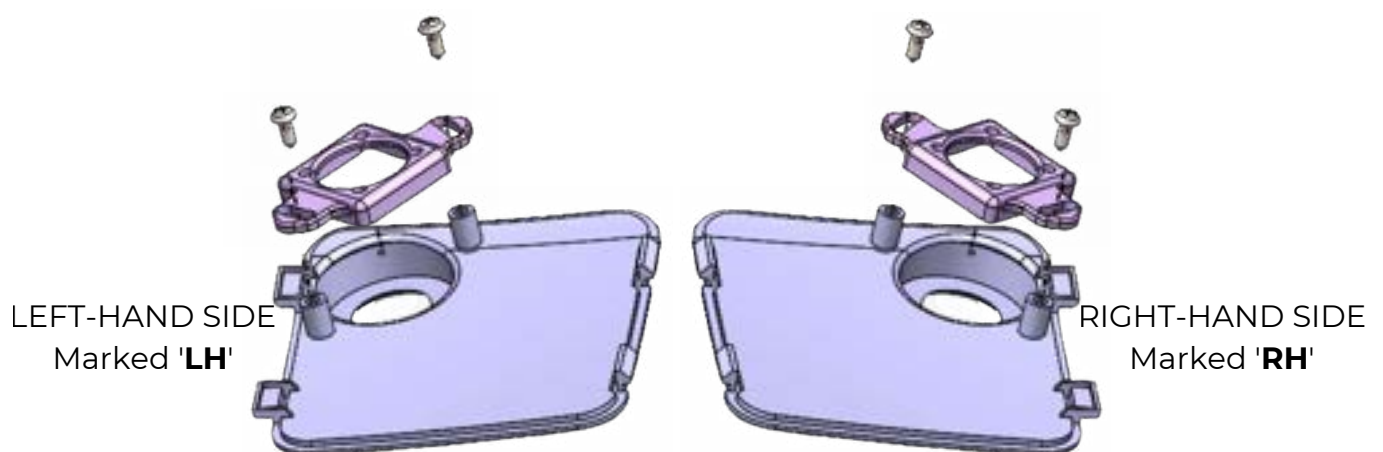

Tip: DO NOT mix up the 360° cameras when removing them from the factory mirror.

- The **LEFT Camera** to be installed in the LEFT-HAND SIDE (LHS) Clearview Towing Mirror; AND
- The **RIGHT Camera** to be installed in the RIGHT-HAND SIDE (RHS) Clearview Towing Mirror.

7.3 Assemble OEM 360° cameras to new bottom access panels. Align the 360° camera in position using the camera brackets and screws provided in the kit.

- Do not securely tighten the screws yet.

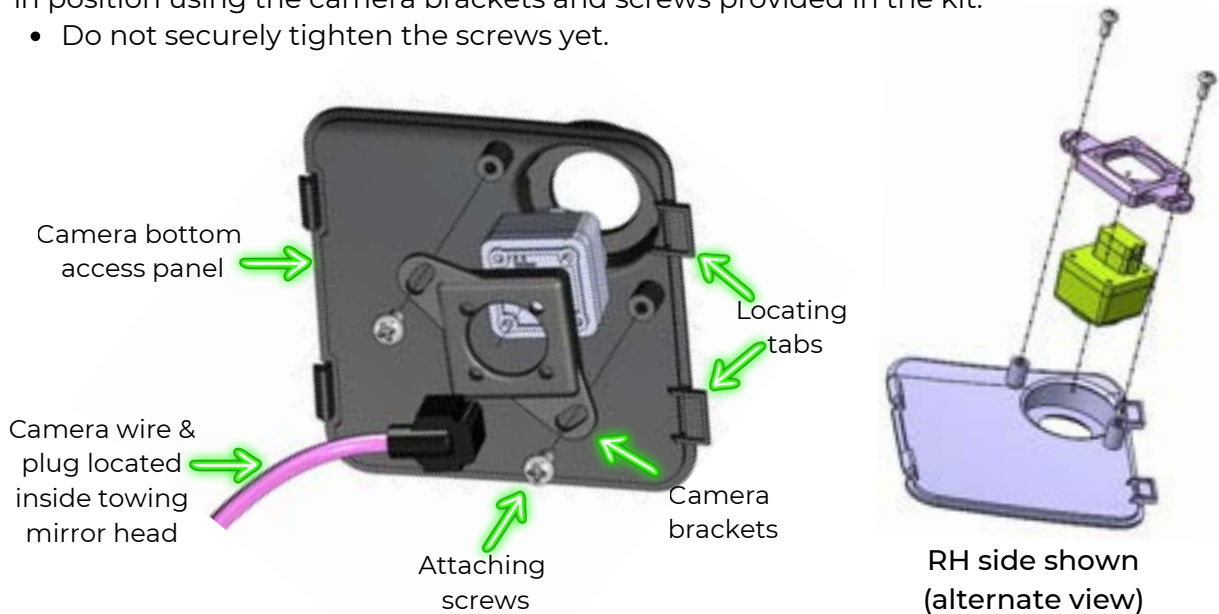

7.4 Align OEM 360° cameras such that the camera bracket wings are positioned over the mounting lugs, as shown.

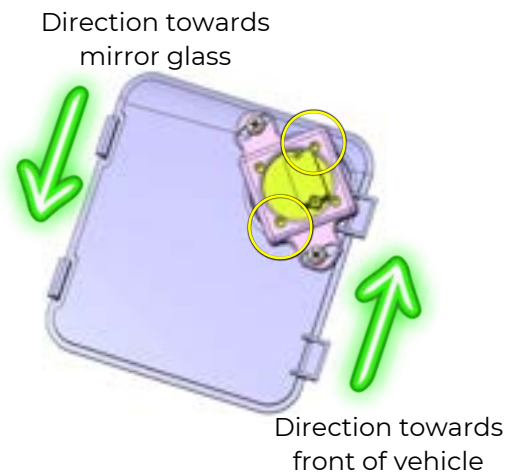

7.5 Secure the OEM 360° cameras to the new camera bracket with the mini screws previously removed from the original vehicle camera brackets. Ensure the White mark on the 360° cameras in STEP 6.1 is toward the mirror glass.

7.6 Position the camera brackets, as shown, with the attaching screws located approximately in the mid-point of the slots.

- The attaching screws can now be fastened, however, may need further adjusting in the subsequent steps.

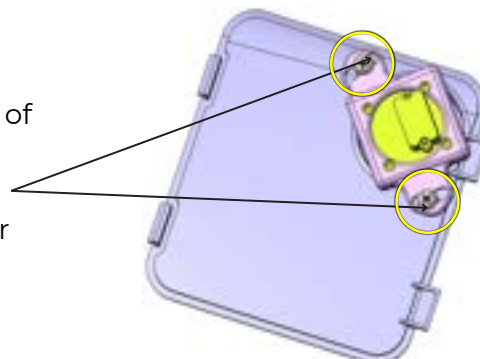

NB: RH Side Images for illustration purposes only

Step 8

Fit bottom access panels with 360° camera to Towing Mirror head:

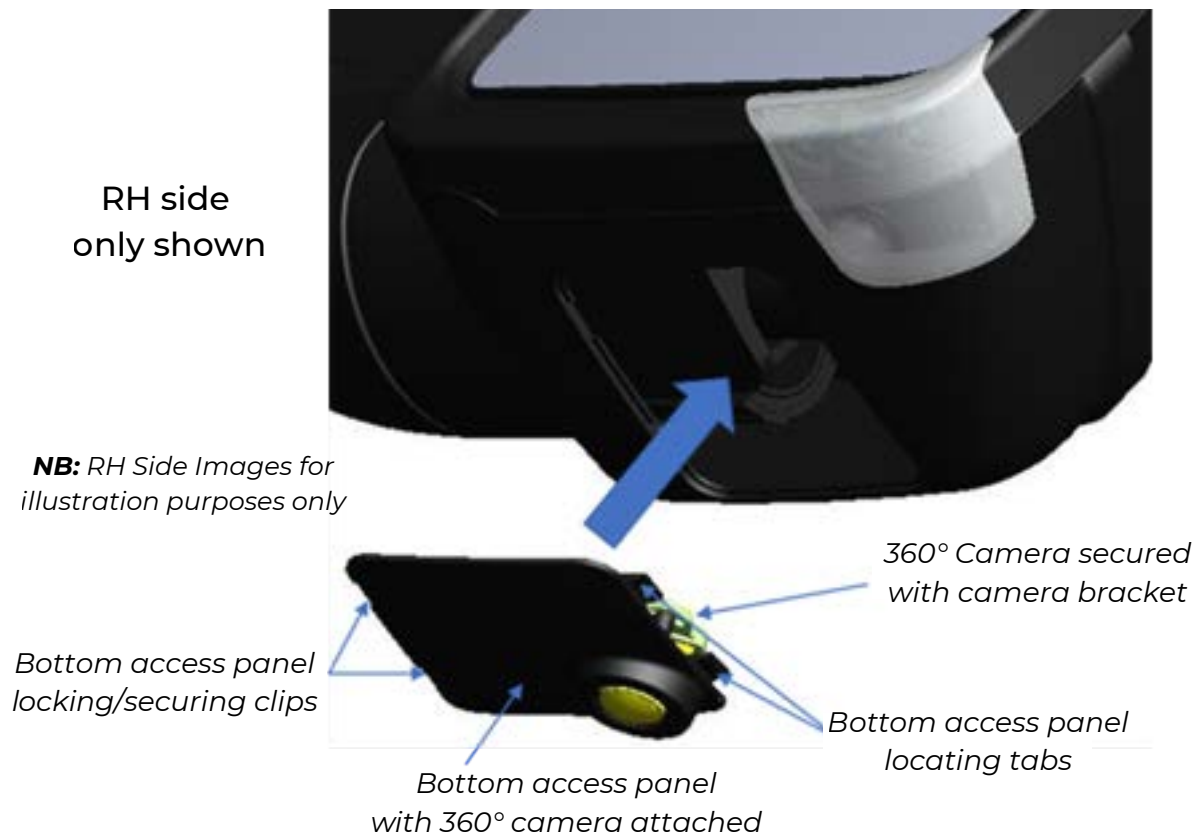

With the OEM 360° camera secured to the bottom access panel – begin with the Right-Hand Side mirror head.

- 8.1** Locate the camera wiring plug immediately inside the mirror head.
- 8.2** Connect the female wiring plug to the mating male plug on the camera wiring lead, the wiring plug will only fit if correctly orientated.
- 8.3** Ensure the 2 mating plugs are completely connected.
- 8.4** As you position the bottom access panel to the mirror head, allow the wiring to fit into the mirror head opening.
- 8.5** Ensure that the wiring is not trapped or interfering with the fitment of the bottom access panel.
- 8.6** Position the lower access panel 2 locating tabs into the slots in the mirror head opening. These slots are on the outside of the mirror head.
- 8.7** Now pivot the inner side of the bottom access panel up until the locking clips are in contact with the mirror head opening.
- 8.8** Apply localised pressure to this edge of the bottom access panel until the locking clips snap into position.
- 8.9** The bottom access panel and camera assembly are now in position.
- 8.10 REPEAT** Steps 8.1 to 8.9 for the LEFT-HAND Side Mirror.

Step 9

Check and adjust camera alignment on vehicle:

9.1 Preparation for testing

- Position the vehicle on a flat, clear surface, and ensure no obstructions when testing.
- Ensure a minimum space of 1 metre is clear on each side of the vehicle.
- Place 2 x parallel lines on the floor surface, approx. 500-600mm away from the vehicle wheels. (The one in our example is 600mm.)
- These parallel lines should run approximately the full length of the vehicle.
- The parallel lines must be thick enough to be visible on the vehicle's 360° camera screen – approx. 50mm thick. The use of masking tape is suggested.

NB: Refer to the vehicle owner's manual for instructions on how to access the vehicle's 360° camera screen.

9.2 View camera alignment

- Turn on the vehicle's 360° camera screen - refer to the vehicle owner's manual.
- With the bottom access panel & 360° camera assembly securely in position on the towing mirrors, close all vehicle doors fully.
- Whilst seated in the vehicle, view the 360° camera screen to check the alignment of the parallel lines on the floor surface.
- You want to see these lines being parallel to the longitudinal centreline of the vehicle, as shown below.
- If the lines are not parallel, you may want to adjust the angle of the 360° camera on the lower access panel until these lines are parallel. Refer to [Step 10](#) for adjustment/alignment instructions.

NB: The alignment does not need to be perfect; this is only a guide, adjust to your preference.

Tip: Complete alignment on one side at a time. Open and close the respective door whilst viewing the lines on the screen. To help determine if you need a clockwise OR anti-clockwise adjustment.

50mm line marked on floor surface approx. 600mm from vehicle wheels. Ensure to be parallel to centerline of vehicle.

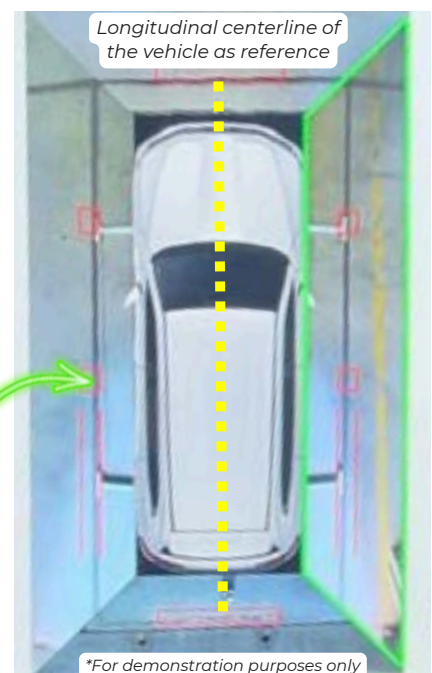
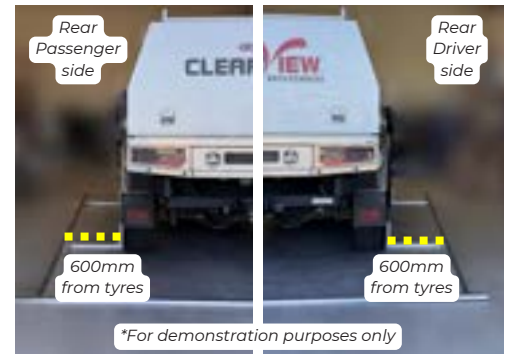
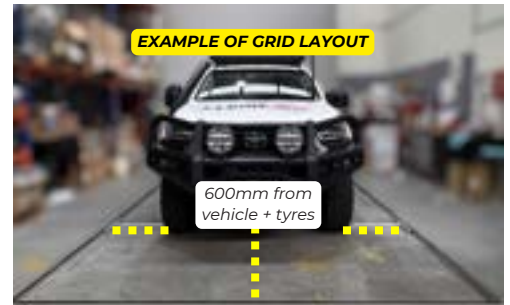

WARNING: THE 360° CAMERA FROM OEM MIRROR IS RELOCATED TO CV MIRROR. SO PARKING GUIDELINES ARE APPROXIMATE AND MIGHT NOT BE THE SAME AS OEM.

Step 10

360° Camera Calibration (via the factory infotainment display)

Toyota Hilux N80 Aug 2023 - Jul 2025 models only

SKIP TO STEP 11: if vehicle has aftermarket screen, OR unable to access vehicle Service Menu.

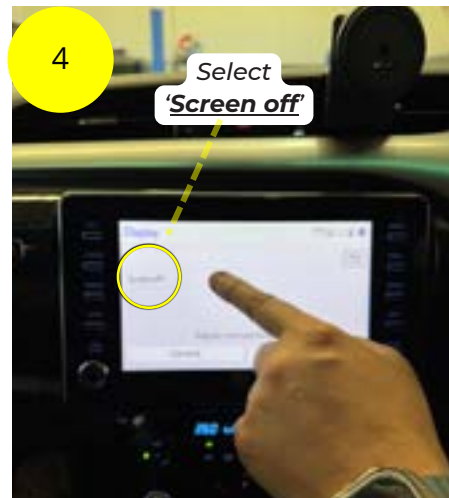
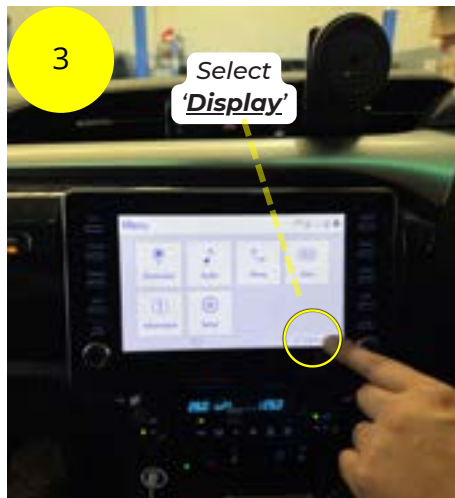
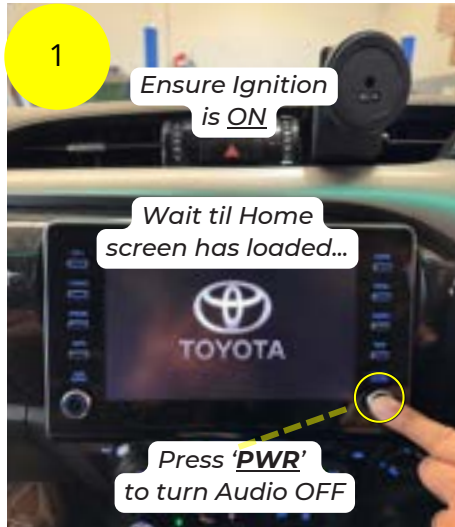

IMPORTANT: Clearview is not responsible for improper use of these functions. Do so at your own preference. Refer to Toyota should you require other assistance regarding the camera system or any other vehicle specific features etc.

Toyota Hilux N80 Aug 2023 - Jul 2025 models only

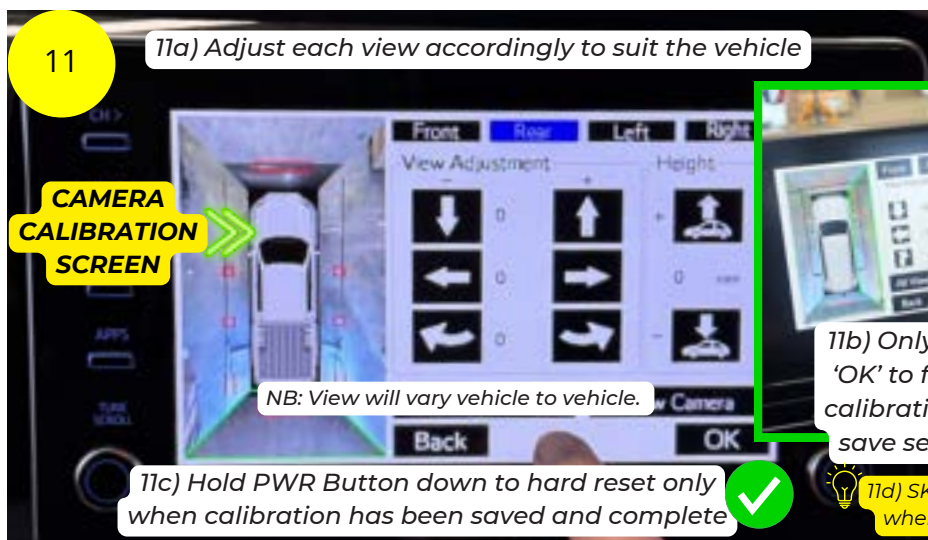
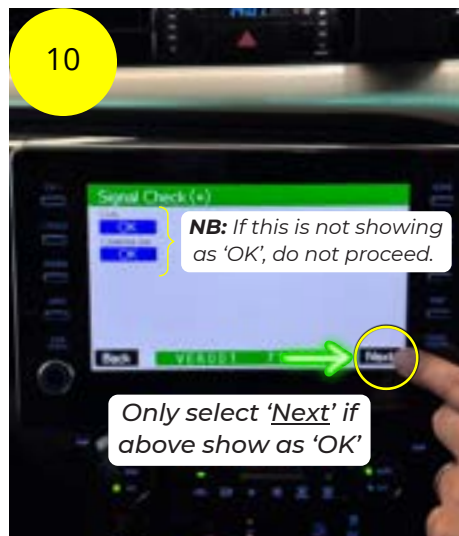
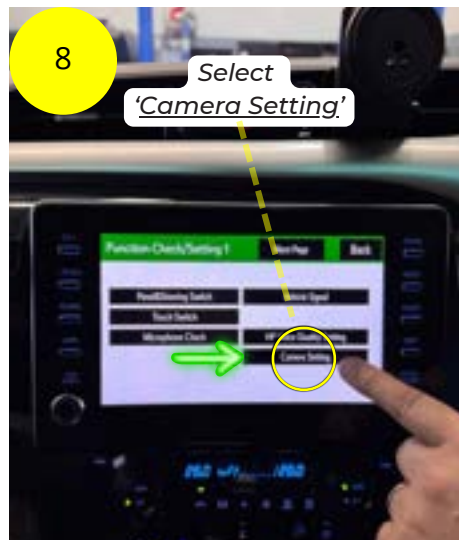
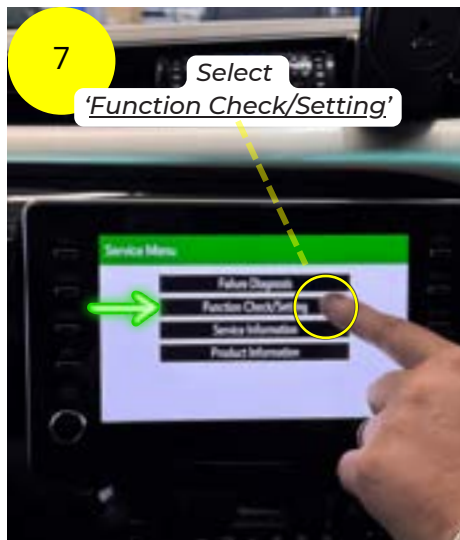

IMPORTANT: Clearview is not responsible for improper use of these functions. Do so at your own preference. Refer to Toyota should you require other assistance regarding the camera system or any other vehicle specific features etc.

Step 11

Adjust 360° camera alignment on vehicle:

NB: Only perform STEP 11 if vehicle has aftermarket screen, OR unable to access vehicle Service Menu.

- 11.1** Switch off the vehicle ignition.
- 11.2** Remove the bottom access panel (with the camera attached) from the mirror head as instructed on previous pages.
- 11.3** If required to gain access to the camera bracket screws, disconnect the wiring plug from the camera wiring lead.
- 11.4** Gently loosen the 2 x attaching screws securing the camera bracket just enough to enable slight movement of the camera bracket and camera assembly.
- 11.5** Maintain downward pressure on the camera bracket so that it does not move prior to your adjustment.
- 11.6** Adjust the camera alignment by rotating the camera bracket & camera assembly a small amount, either clockwise or anti-clockwise, to the desired position.
- 11.7** Re-secure the 2 x attaching screws to fasten the camera in the adjusted position.
- 11.8** Re-connect the 360° camera wiring plug.
- 11.9** Re-fit the lower access panel with the 360° camera secured in the adjusted position back into the mirror head as instructed on previous pages.

NB: You may need to **REPEAT 'Adjust 360° camera alignment on vehicles'**; AND/OR **'View Camera Alignment'** steps until you are satisfied with the alignment of cameras to the parallel lines on both sides of the vehicle.

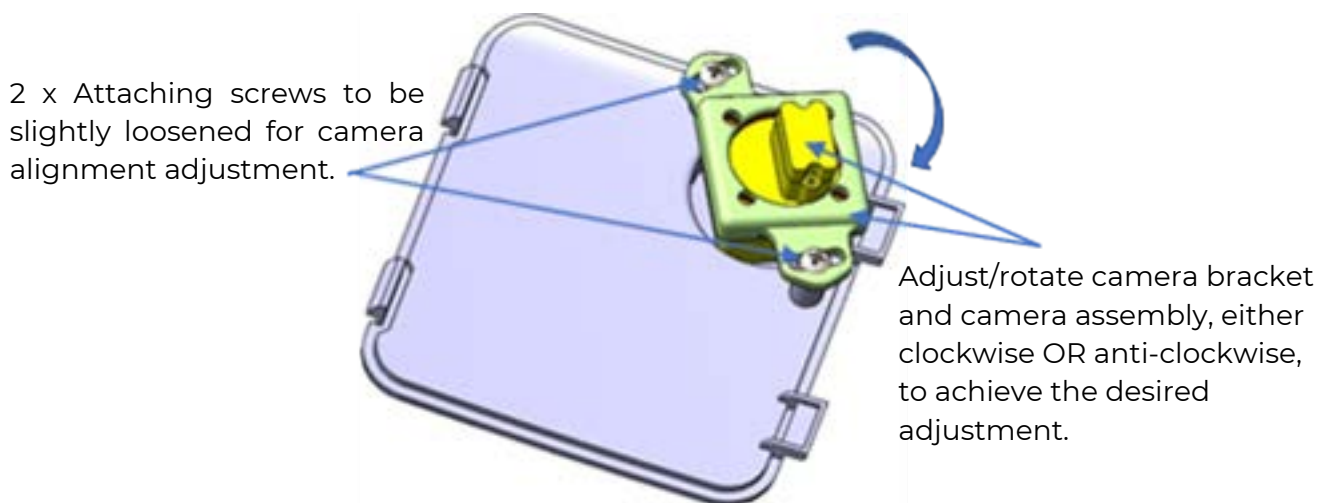

NB: If the vehicle has an aftermarket screen, please refer to the relevant user guide for camera adjustment where applicable.

- This step is only a guide for manual adjustment when unable to do so via the vehicle's infotainment screen.

NB: RH Side Images for illustration purposes only

Step 12

Test the Mirrors

12.1 The battery **-ve Terminal**, which was disconnected at **STEP 1**, can now be reconnected.

12.2 Begin testing to ensure the Clearview Mirrors are operating correctly.

- Turn ignition ON and operate the mirror function of Towing Mirror based on features available in vehicle.
- Test your mirror functionality to ensure they run the correct way - UP, DOWN, LEFT, RIGHT, etc.
- Indicate LEFT, Indicate RIGHT, Test HAZARD Lights, etc.

NB: If your mirror/s are not functioning properly, refer to Troubleshooting on [Pages 22 & 23](#), or follow the instructions again in case a step has been missed.



Step 13

Re-assemble the door trim

13.1 Re-align and secure the door trims into their original position, ensuring no wires or cables are trapped in the process.

- Around the door trim, there are retainer clips/fasteners that need to be re-aligned to the holes in the door skin.
- Once all are re-aligned, press and clip them back in place. You will hear the clips clicking in as you work your way around securing the trim.

13.2 REPEAT [STEPS 1 - 3](#) in REVERSE ORDER.

NB: Once the door trim is installed, please check the operation of the mirror once more to ensure that nothing went wrong during the reinstallation of the door trims.



Congratulations! You have now fully installed your new Clearview Towing Mirrors and are ready for your next adventure!

Maintaining Powder Coated Surfaces

Whilst powder coating is a lot more durable, and longer lasting than paint, it can still be affected by dust, dirt, salt water and constant exposure to the weather. For this reason, no protective powder coating is completely maintenance-free.

With the right maintenance, you can increase the life of the finish of your powder-coated surfaces:

- Harsh chemicals and solvents can damage powder coating. Once damaged, the surface is a lot more vulnerable to fading and failure.
- We recommend regularly inspecting your powder coat and wiping any dust off with a soft cloth. Clean, good-quality microfiber cloths are recommended.
- We recommend regular washing with highly diluted mild soap and water. Use a soft towel to gently clean. Rinse and dry with another soft towel.
- If your powder coat is losing its shine, you can apply a thin layer of high-grade non-abrasive car wax after it's been cleaned. Wipe all the wax off once it's dried, and the powder coat should look like new again! Use a car wax brand that contains a UV blocker or UV inhibitors. Do not use compound-type waxes as they contain abrasives that can harm the powder coating.

It's important in coastal areas to regularly clean any powder-coated surfaces, as salt will stick to the coating, dulling its appearance. This can leave your powder-coated surface looking chalky.

We don't recommend paint touch-ups to cover imperfections, as paint won't adhere to powder-coated surfaces. A local professional can quote to repair the powder coating.

How do I maintain my Powerfold mirrors?

Under normal Powerfold operation, there shouldn't be any maintenance required. However, if it is regularly used off-road, then the mirrors may need to be maintained every 12 months. This maintenance involves pulling the mirror into the fully extended position and applying dry lubricant on the arms.

Maintaining your Chrome Mirrors

The chrome finish used on our mirror heads is a chrome-plated plastic, which provides the appearance and feel of real chrome, in a more lightweight and cost-effective material. Weather conditions, how often they are washed and how close to the ocean you live, all play a role in the longevity of the chrome finish.

- Automatic car washes that use bristle brushes or acidic preparations can damage your chrome
- Salt and de-icers will surface pit chrome, and extra care will be required with more frequent washes to remove residue.
- We recommend washing them weekly with mild soap and water, steering clear of ammonia-based or acid solutions.
- Clean, good-quality microfiber cloths are recommended to wipe down the chrome surface and prevent water stains from forming
- An occasional polish with a non-abrasive chrome polish will help bring your chrome back to its original shine!

If chrome isn't properly maintained, it can develop pitting from corrosion or lose its attractive shine. We recommend Autosol Metal Polish and Autosol Metal Life Saver.

Can I install Clearview mirrors myself?

Yes! Depending on the complexity of the installation, Clearview mirrors are extremely easy to install and mount to the vehicle's original OEM mirror mounts. Depending on the vehicle's current mirror options, Clearview mirrors include plug and play wiring looms. Instructional videos are also available on our website (clearviewaccessories.com.au) in the "HOW TO" section. Clearview recommends that any installation requiring hard wiring be done by a licensed auto electrician.

What is the fitting time?

Depending on the complexity of the installation, a dealer should be able to install the mirrors in approximately 15 minutes per side of the vehicle. Installation requiring special fitting and/or hard wiring will require longer fitting times (eg: Camera and electric wiring kits). Note: The 70 Series mirrors with electrics are more complex and will take more time than a 'normal' vehicle fitting. Please contact Clearview mirrors if you have any questions about fitting or wiring.

Are the telescopic arms electric?

No. The telescopic arms are extended manually. Clearview Mirrors will only fold against the vehicle electronically provided we make that model in Power Fold.

Can I retrofit the original mirror base to the Next Gen or Compact mirrors?

No. The cost of converting the mirrors to suit the new models is not worth it. We recommend either selling your Original mirrors privately or through the "Pre-Loved" section (Within the "Shop" menu category) of our website and purchasing the new Next Gen or Compact mirrors brand new.

Can I add an indicator later if I didn't order the mirrors with an indicator?

Yes, you can. But it comes at a greater expense than if you were to order the mirrors with indicators. Installation to the mirror head will require longer time and more parts to dismantle.

Are spare parts available?

Yes. We have a list of spare parts for all our mirrors on our website. Our dealers also have a list of all our spare parts.. If you cannot find the parts that you require, please contact us or any of our dealers to assist you with your inquiry

How do I maintain my mirrors?

We recommend that Clearview Mirrors are lubricated every 6-12 months, when the arms feel stiff during use, or after any big trip to ensure longevity of your Clearview Towing Mirrors!

This maintenance includes pulling the mirror into the fully extended position and applying the dry lubricant on the arms. We recommend using WD-40 Specialist® Dry Lubricant



Avoid any waxy lubricants as they can attract dirt and grit.

**SCAN THE QR CODE
AND VIEW OUR VIDEO
DEMONSTRATING**

How to lubricate the arms
on Clearview Towing Mirrors



I have just installed my new Powerfold mirrors and the mirror heads appear 'loose'/'floppy'.

After the mirrors are installed, they need to be cycled a few times. This will allow all the internal mechanisms to set and find the proper positions.

- If the mirror head is still loose/floppy after they're cycled, please contact Clearview Technical Support.

I have installed my Powerfold Mirrors and have noticed that the Passenger's side mirror is closer to the vehicle compared to the Driver's side; Is this normal?

This is entirely normal. In most vehicles, the mirror housings are angled differently between the driver's and passenger's sides.

- This is because when you sit in the car, the mirrors are positioned from/to the driver's position (which is off-centre), so generally, the passenger side mirrors are closer to the vehicle body to allow you to have the same field of vision in the mirror.

One of my Powerfold Mirrors folds/opens quicker than the other one; Is this normal?

Generally, the passenger mirror will fold/open quicker, as it is closer to the vehicle body and therefore travels a shorter distance compared to the driver's side mirror. See previous question in regards to why the mirrors are angled differently.

My mirrors have been knocked out of Driving Position; how do I fix it?

Press the powerfold switch once. This should initiate the powerfolding motors and the mirrors should start folding inwards. Wait until the mirrors are fully folded in and have stopped moving, then press the powerfold switch again. This should now bring your mirrors back out to normal driving position. Check and see if the mirrors are locked into position firmly. If the mirror is not returning to the normal position, please contact Clearview Technical Support.

- **Note:** *The Powerfold mirrors can fold manually, however the manual fold mechanism is only designed as a safety feature. Through the lifespan of the product, manual folding will occur, such as people walking into them or accidentally bumping them. The internal mechanisms are designed to withstand this accidental manual folding during normal usage. It is not recommended for the mirrors to be manually folded constantly, as it will prematurely wear out the internal folding mechanisms and reduce the lifespan of the product.*

My mirror was knocked out of driving position. When I cycled them, there is a clicking sound and the mirror appears to have “jumped”; Are my mirrors damaged?

When the Powerfold mirror is being cycled to find its original driving position, it will “jump” back into position and make an audible click sound when mechanisms realign. Once the mirrors have found the original position and have been cycled, check for looseness and mirror movement. If they feel firm, then the mirrors have not been damaged. If they still feel loose, please contact Clearview Technical Support.

Why don't my mirrors fold all the way in/out when I press the switch?

The circuit breaker inside the mirror activates when the electrical current increases due to resistance. If the mirror stops before it reaches the folded in/out position, that means something is adding resistance while the mirrors are folding, hence activating the circuit breaker before it has reached the desired position. Please contact Clearview Technical Support.

Clearview Towing Mirrors® are full replacement towing mirrors designed and manufactured to the highest quality standards to replace your vehicle's standard side mirrors. We stand behind our Next Gen and Compact Towing Mirrors with a 3-year Manufacturer's Warranty and 7-year Parts Warranty. We stand behind our Original Towing Mirrors and Classic Towing Mirrors with a 12-Month Manufacturer's Warranty and 3-year Parts Warranty

Please ensure that your receipt is kept in a safe place. A receipt will be required to make a warranty claim on any Clearview product. If we determine that a Clearview Towing Mirror is defective in materials or workmanship during the Warranty, we will either repair or replace the product. Repair or replacement is solely at the discretion of Clearview Accessories.

Please ensure that you fit the Clearview products in accordance with the product information provided and all relevant vehicle safety and compliance laws; and use the Clearview product for the purpose for which it was originally designed. This warranty does not apply to failure or damage caused by incorrect or faulty fitment, accidental or intentional damage, alteration, acts of nature, vandalism, collision, road hazards or adverse conditions, misuse, abuse or neglect of the Clearview product, including improper repair or maintenance or failing to repair and maintain the product, failure of other products, operation of the product outside of its environmental or technical specifications, or repair or modification carried out by anyone other than Clearview Accessories®. No charges will be accepted for external labour or materials without the prior advice or clearance from Clearview claims team. Clearview Accessories® warranty does not cover any scratches or chips.

Clearview Towing Mirrors are designed to be vehicle-specific. When purchasing Clearview Towing Mirrors, carefully select your product according to ADR compliance laws and vehicle specifications. Clearview Towing Mirrors are not designed to be modified for convenient use on alternative vehicles. Alteration, modification, or manipulation of our products will void all warranty with Clearview Accessories.

All claims under this warranty should be lodged through our website warranty section <https://www.clearviewaccessories.com.au/about/warranty/> with the detail of the fault, proof of purchase, proof of identification and vehicle fitment details where relevant. If your claim is accepted for defects in material or workmanship Clearview will, at its discretion, offer to repair, replace parts, or return and refund.

Our goods come with guarantees that cannot be excluded under the Australian Consumer Law. You are entitled to a replacement or refund for a major failure and for compensation for any other reasonably foreseeable loss or damage. You are also entitled to have the goods repaired or replaced if the goods fail to be of acceptable quality and the failure does not amount to a major failure. In the event of a minor failure, the company reserves the right to choose to repair or replace the product.

Clearview Towing Mirrors® | ABN: 59 140 145 393 | 3 Frog Court, Craigieburn VIC 3064
Phone: (03) 8351 9933 | Email: info@clearviewaccessories.com.au

Towing Mirrors

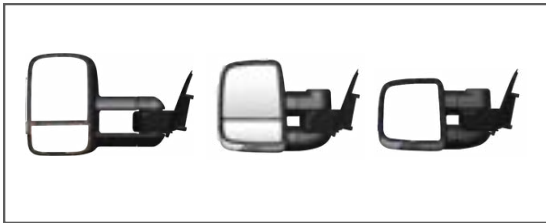

Power Boards & Swing Boards



Rock Tamers



Tyre Spider

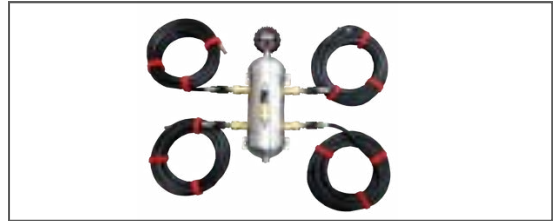

Easy Slides



Power Slides



Expanda Slides



Fridge Cage



Pantry

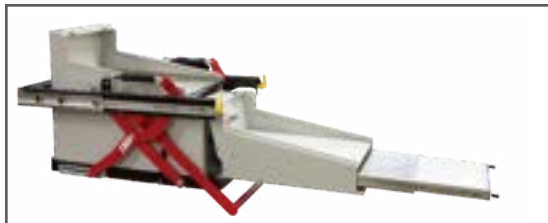

Cutlery Set



Clip on Trays

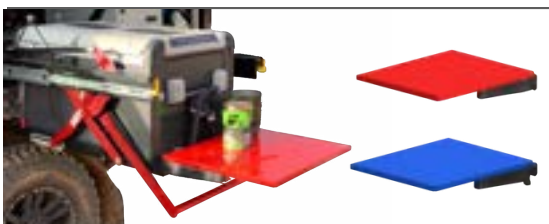

Cable Saver

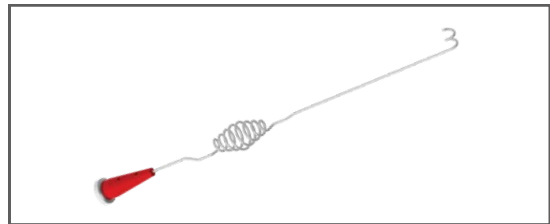



CLEARVIEW[®]
ACCESSORIES

Head Office

3 Frog Court, Craigieburn
VIC 3064, Australia
(03) 8351 9933

QLD Office

Unit 1/49 Doherty Street, Brendale
QLD 4500, Australia
(07) 3204 7693

info@clearviewaccessories.com.au

clearviewaccessories.com.au